



Cat. No. 140G-G6C3-D12

Bulletin 140G Molded Case Circuit Breakers

- 10..3000 A current range
- 3- & 4-pole devices
- Space-saving dimensions
- Thermal/Magnetic protection: 15..800 A
- Electronic protection: 10..3000 A
- Approved for global application: UL, CSA, CCC, and IEC performance interrupting/breaking capacity
- Wide range of mounting options
- Extensive range of factory- or field-installed accessories

The Bulletin 140G family of Molded Case Circuit Breakers (MCCBs) offers a wide range of features include thermal/magnetic and electronic protection devices, high interrupting/breaking capacities and a complete line of factory and field installed accessories. The Bulletin 140G MCCBs are ideal for use in line protection of control panels.

Table of Contents

Overview 3
 Product Selection 5
 Accessories 50
 Specifications 64
 Approximate Dimensions 68

Standards Compliance

IEC 60947-2
 UL489
 CSA22.2, No. 5

Certifications

CE Marked
 CCC
 CSA Certified
 UL Listed



G-Frame



H-Frame



I-Frame



J-Frame



K-Frame



M-Frame



N-, NS-Frame



R-Frame

Frame Reference	G-Frame	H-Frame	I-Frame	J-Frame	K-Frame	M-Frame	N-Frame	NS-Frame	R-Frame
Rated Current I_n	125 A	125 A	225 A	250 A	400 A	800 A	1200 A	1200 A	3000 A
No. of Poles	3, 4	3, 4	3, 4	3, 4	3, 4	3, 4	3, 4	3, 4	3, 4
Interrupting Rating [kA]									
240V	50 65 100	65 100 150 200 200	50 65	65 100 150 200	100 150 200 200	100 200 200	65 100 150	65 100 150	125
480V	25 35 65	25 35 65 100 150	25 35	25 35 65 100	35 65 100 150	50 65 100	50 65 100	50 65 100	125
600Y/347V	10 14 25	—	10 10	—	—	—	—	—	—
600V	—	14 18 25 35	10 10	14 18 25 35	25 35 65 100	25 35 42	25 50 65	25 50 65	100
Breaking Capacity [I_{cu} (kA)]									
220...240V	65 85 100	65 85 100 150 200	65 85	65 85 100 150	85 100 200 200	85 100 200	85 100 200	85 100 200	130
415V	36 50 70	36 50 70 120 150	36 50	36 50 70 120	50 70 120 200	36 70 100	50 70 120	50 70 120	80
440V	36 50 65	36 50 65 100 150	25 40	36 50 65 100	40 65 100 180	35 50 65	50 65 100	50 65 100	80
690V	6 8 10	10 12 15 18 20	5 8	10 12 15 20	25 40 70 80	22 25 30	30 42 50	30 42 50	40
250V DC	36 50 70	36 50 70 85 100	36 50	36 50 70 85	—	36 50 65	—	—	—
500V DC	36 50 70	36 50 70 85 100	36 50	36 50 70 85	36 50 70 100	—	—	—	—
750V DC	—	—	—	—	25 36 70 70	16 36 50	—	—	—
Protection Type									
Thermal Magnetic	✓	✓	✓	✓	✓	✓	—	—	—
Electronic	—	✓	—	✓	✓	✓	✓	✓	✓
Molded Case Switch	✓	✓	✓	✓	✓	✓	✓	✓	✓
Internal Accessories									
Auxiliary Contact	✓	✓	✓	✓	✓	✓	✓	✓	✓
Alarm Contact	✓	✓	✓	✓	✓	✓	✓	✓	✓
AX/AL Combo	✓	✓	✓	✓	✓	✓	✓	✓	✓
Trip Unit Contact	—	✓	—	✓	—	—	✓	✓	✓
Shunt Trip	✓	✓	✓	✓	✓	✓	✓	✓	✓
Shunt Close	—	—	—	—	—	—	✓	✓	✓
UV Relay	✓	✓	✓	✓	✓	✓	✓	✓	✓
Field Installable	✓	✓	✓	✓	✓	✓	✓	✓	✓
External Accessories									
End Cap	STD	STD	STD	STD	STD	STD	STD	STD	—
25 mm Phase Barriers	STD	STD	STD	STD	STD	—	—	—	—
Insulators	STD	STD	STD	STD	STD	STD	—	—	—
Terminal Lugs	✓	✓	✓	✓	✓	✓	✓	✓	✓
Extended Terminal	✓	✓	✓	✓	✓	✓	✓	✓	—
Spreader Terminal	✓	✓	✓	✓	✓	✓	✓	✓	✓
Rear Terminal	—	—	—	—	—	—	✓	✓	✓
Phase barriers	✓	✓	✓	✓	✓	✓	✓	✓	✓
Terminal Cover	✓	✓	✓	✓	✓	✓	✓	✓	—
Direct Rotary	✓	✓	✓	✓	✓	✓	✓	—	—
Variable Depth (Door)	✓	✓	✓	✓	✓	✓	✓	—	—
Internal NFPA 79	✓	✓	✓	✓	✓	✓	✓	—	—
Flange Operator	✓	✓	✓	✓	✓	✓	✓	—	—
Flange Cable	✓	✓	✓	✓	✓	✓	✓	—	—
Motor Operator	✓	✓	✓	✓	✓	✓	—	✓	✓
Field Installable	✓	✓	✓	✓	✓	✓	✓	✓	✓

Molded Case Circuit Breakers

Catalog Number Explanation — 125 A, H-Frame

Complete Circuit Breaker Assemblies — 125 A, H-Frame

Examples given in this section are not intended to be used for product selection. Use ProposalWorks to configure the molded case circuit breaker. Use these configurations only to select all factory-installed options for shunt trips, undervoltage release units, auxiliary contacts, trip units, and alarm contacts. Use the codes from Table g to add on to the molded case circuit breaker cat. no. selected on the previous pages to form a complete cat. no. for a complete assembly with factory-installed options.



140G - H
3
C
3 - C60 - SD - AA

a
b
c
d
e
f
g

a

Bulletin No.	
Code	Description
140G	Global Molded Case Circuit Breaker

b

Frame/Rating	
Code	Description
H	125 A

c

Interrupting Rating/Breaking Capacity (based on I_c at 480V)	
Code	Description
2	25 kA
3	35 kA
6	65 kA
0	100 kA
15	150 kA
T	Trip unit

d

Protection Type	
Code	Description
C	Fixed thermal/fixed magnetic
F	Adjust thermal/ adjust magnetic
H	Electronic LSI- long, short, instant
I	Electronic LSIG -Long, short, instant & ground fault
X	Breaker frame
S	Molded case switch (isolator)

e

Poles	
Code	Description
3	3 poles
4	4 poles

f

Current Range	
Code	Description
C	e.g., C30 = 30 A
D	e.g., D16 = 160 A
Blank	Frame only

g

Factory-Installed Internal Options♦	
Shunt Trip and Undervoltage Release Units	
Code	Description
SJ	Shunt Trip, 24...30V AC/DC
SK	Shunt Trip, 48...60V AC/DC
SD	Shunt Trip, 110...127V AC; 110...125V DC
SA	Shunt Trip, 220...240V AC; 220...250V DC
SB	Shunt Trip, 380...440V AC
SC	Shunt Trip, 480...525V AC
UJ	Undervoltage Release, 24...30V AC/DC
UR	Undervoltage Release, 48V AC/DC
UD	Undervoltage Release, 110...127V AC; 110...125V DC
UA	Undervoltage Release, 220...240V AC; 220...250V DC
UB	Undervoltage Release, 380...440V AC
UC	Undervoltage Release, 480...525V AC
No Digit	No Selection
Auxiliary and Alarm Contacts, Trip Units	
Code	Description
KA	1 Aux. Contact, 250V
TA	1 Alarm Contact, 250V
AA	1 Aux., 1 Alarm Contact, 250V
BA	2 Aux., 1 Alarm Contact, 250V
DA	1 Trip Unit Alarm Contact, 250V
FB	2 Aux. Contacts, 400V
AB	1 Aux., 1 Alarm Contact, 400V
AJ	1 Aux., 1 Alarm Contact, 24V
DJ	1 Trip Unit Alarm Contact, 24V

♦ Select up to two internal options: 1 for left side mounting (shunt trip or undervoltage release), 1 for right (auxiliary or alarm contact). Consult your local Rockwell automation sales office or Allen-Bradley distributor for further assistance.

Breaker Frames & Trip Units



Breaker Frames, 125 A Rated Current

Interrupting Rating (50/60 Hz), UL 489/CSA C22.2-5, No. 5-02 [kA]			Breaking Capacity (50/60 Hz), IEC 60947-2								Breaking Capacity (DC), IEC 60947-2 ‡				Cat. No.	
240V	480V	600V	220V★		415V		440V★		690V		250V DC (2- pole in series)		500V DC (3- pole in series)		3 Poles	4 Poles
			I_{cu} [kA]	I_{cs} [% I_{cu}]	I_{cu} [kA]	I_{cs} [% I_{cu}]	I_{cu} [kA]	I_{cs} [% I_{cu}]	I_{cu} [kA]	I_{cs} [% I_{cu}]	I_{cu} [kA]	I_{cs} [% I_{cu}]	I_{cu} [kA]	I_{cs} [% I_{cu}]		
65	25	14	65	100	36	100	36	100	10	100	36	100	36	100	140G-H2X3	140G-H2X4
100	35	18	85	100	50	100	50	100	12	100	50	100	50	100	140G-H3X3	140G-H3X4
150	65	25	100	100	70	100	65	100	15	100	70	100	70	100	140G-H6X3	140G-H6X4
200	100	35	150	100	120	100	100	100	18	75	85	100	85	100	140G-H0X3	140G-H0X4
200	150	—	200	100	150	100	150	100	20	75	100	100	100	100	140G-H15X3	140G-H15X4

★ These ratings have not been tested for the CCC listing.
 ‡ DC rating is applicable for thermal-magnetic trip unit only.

Trip Units, Thermal-Magnetic

Rated Current I_n [A]	Thermal Trip [A] $I_r = I_n$	Magnetic Trip [A] I_m	Protection Type	Cat. No.	
				3 Poles	4 Poles
50	50	500	C (Fixed)	140G-HTC3-C50	140G-HTC4-C50
60	60	600	C (Fixed)	140G-HTC3-C60	140G-HTC4-C60
63	63	630	C (Fixed)	140G-HTC3-C63	140G-HTC4-C63
70	70	700	C (Fixed)	140G-HTC3-C70	140G-HTC4-C70
80	56...80	400...800	F (Adjustable)	140G-HTF3-C80	140G-HTF4-C80
90	63...90	450...900	F (Adjustable)	140G-HTF3-C90	140G-HTF4-C90
100	70...100	500...1000	F (Adjustable)	140G-HTF3-D10	140G-HTF4-D10
110	77...110	550...1100	F (Adjustable)	140G-HTF3-D11	140G-HTF4-D11
125	87...125	625...1250	F (Adjustable)	140G-HTF3-D12	140G-HTF4-D12

Trip Units, Electronic LSI (Long, Short, Instantaneous)

Rated Current I_n [A]	Protection Type					Cat. No.	
	L		S		I	3 Poles	4 Poles
	$I_1=0.4...1 \times I_n$	$t_1=sec.$	$I_2=1...10 \times I_n$	$t_2=sec.$	$I_3=1...10 \times I_n$		
60	24...60	3, 12, 36, 60	60...600	0.05, 0.1, 0.2, 0.4	60...600	140G-HTH3-C60	140G-HTH4-C60
100	40...100	3, 12, 36, 60	100...1000	0.05, 0.1, 0.2, 0.4	100...1000	140G-HTH3-D10	140G-HTH4-D10
125	50...125	3, 12, 36, 60	125...1250	0.05, 0.1, 0.2, 0.4	125...1250	140G-HTH3-D12	140G-HTH4-D12

Trip Units, Electronic LSIG (Long, Short, Instantaneous, Ground Fault)

Rated Current I_n [A]	Protection Type							Cat. No.	
	L		S		I	G		3 Poles	4 Poles
	$I_1=0.4...1 \times I_n$	$t_1=sec.$	$I_2=1...10 \times I_n$	$t_2=sec.$	$I_3=1...10 \times I_n$	$I_4=0.2...1 \times I_n$	$t_4=sec.$		
60	24...60	3, 12, 36, 60	60...600	0.05, 0.1, 0.2, 0.4	60...600	12...60	0.1, 0.2, 0.4, 0.8	140G-HTI3-C60	140G-HTI4-C60
100	40...100	3, 12, 36, 60	100...1000	0.05, 0.1, 0.2, 0.4	100...1000	20...100	0.1, 0.2, 0.4, 0.8	140G-HTI3-D10	140G-HTI4-D10
125	50...125	3, 12, 36, 60	125...1250	0.05, 0.1, 0.2, 0.4	125...1250	25...125	0.1, 0.2, 0.4, 0.8	140G-HTI3-D12	140G-HTI4-D12

Assembled molded case circuit breakers found on pages 8...10

Molded Case Circuit Breakers

Product Selection — 125 A, H-Frame

Assembled Molded Case Circuit Breakers — 125 A, H-Frame Interrupting Rating/Breaking Capacity — Thermal-Magnetic Circuit Breakers

Interrupting Rating (50/60 Hz), UL 489/CSA C22.2-5, No. 5-02 [kA]			Breaking Capacity (50/60 Hz), IEC 60947-2								Breaking Capacity (DC), IEC 60947-2 §				Interrupting Code‡
240V	480V	600V	220V★		415V		440V★		690V		250V DC (2-pole in series)		500V DC (3-pole in series)		
			I_{cu} [kA]	I_{cs} [% I_{cu}]	I_{cu} [kA]	I_{cs} [% I_{cu}]	I_{cu} [kA]	I_{cs} [% I_{cu}]	I_{cu} [kA]	I_{cs} [% I_{cu}]	I_{cu} [kA]	I_{cs} [% I_{cu}]	I_{cu} [kA]	I_{cs} [% I_{cu}]	
65	25	14	65	100	36	100	36	100	10	100	36	100	36	100	H2
100	35	18	85	100	50	100	50	100	12	100	50	100	50	100	H3
150	65	25	100	100	70	100	65	100	15	100	70	100	70	100	H6
200	100	35	150	100	120	100	100	100	18	75	85	100	85	100	H0
200	150	42	200	100	150	100	150	100	20	75	100	100	100	100	H15

★ These ratings have not been tested for the CCC listing.

‡ See table below for Cat. No. selection

§ DC rating is applicable for thermal-magnetic trip unit only.

Thermal-Magnetic, Fixed & Adjustable

Rated Current I_n [A]	Thermal Trip [A] $I_r = I_n$	Magnetic Trip [A] I_m	Interrupting Code H2		Interrupting Code H3		Interrupting Code H6	
			Cat. No.		Cat. No.		Cat. No.	
			3 Poles	4 Poles	3 Poles	4 Poles	3 Poles	4 Poles
15	15	400	140G-H2C3-C15	140G-H2C4-C15	140G-H3C3-C15	140G-H3C4-C15	140G-H6C3-C15	140G-H6C4-C15
16	16	400	140G-H2C3-C16	140G-H2C4-C16	140G-H3C3-C16	140G-H3C4-C16	140G-H6C3-C16	140G-H6C4-C16
20	20	400	140G-H2C3-C20	140G-H2C4-C20	140G-H3C3-C20	140G-H3C4-C20	140G-H6C3-C20	140G-H6C4-C20
25	25	400	140G-H2C3-C25	140G-H2C4-C25	140G-H3C3-C25	140G-H3C4-C25	140G-H6C3-C25	140G-H6C4-C25
30	30	400	140G-H2C3-C30	140G-H2C4-C30	140G-H3C3-C30	140G-H3C4-C30	140G-H6C3-C30	140G-H6C4-C30
32	32	400	140G-H2C3-C32	140G-H2C4-C32	140G-H3C3-C32	140G-H3C4-C32	140G-H6C3-C32	140G-H6C4-C32
35	35	400	140G-H2C3-C35	140G-H2C4-C35	140G-H3C3-C35	140G-H3C4-C35	140G-H6C3-C35	140G-H6C4-C35
40	40	400	140G-H2C3-C40	140G-H2C4-C40	140G-H3C3-C40	140G-H3C4-C40	140G-H6C3-C40	140G-H6C4-C40
50	50	500	140G-H2C3-C50	140G-H2C4-C50	140G-H3C3-C50	140G-H3C4-C50	140G-H6C3-C50	140G-H6C4-C50
60	60	600	140G-H2C3-C60	140G-H2C4-C60	140G-H3C3-C60	140G-H3C4-C60	140G-H6C3-C60	140G-H6C4-C60
63	63	630	140G-H2C3-C63	140G-H2C4-C63	140G-H3C3-C63	140G-H3C4-C63	140G-H6C3-C63	140G-H6C4-C63
70	70	700	140G-H2C3-C70	140G-H2C4-C70	140G-H3C3-C70	140G-H3C4-C70	140G-H6C3-C70	140G-H6C4-C70
80	56...80	400...800	140G-H2F3-C80	140G-H2F4-C80	140G-H3F3-C80	140G-H3F4-C80	140G-H6F3-C80	140G-H6F4-C80
90	63...90	450...900	140G-H2F3-C90	140G-H2F4-C90	140G-H3F3-C90	140G-H3F4-C90	140G-H6F3-C90	140G-H6F4-C90
100	70...100	500...1000	140G-H2F3-D10	140G-H2F4-D10	140G-H3F3-D10	140G-H3F4-D10	140G-H6F3-D10	140G-H6F4-D10
110	77...110	550...1100	140G-H2F3-D11	140G-H2F4-D11	140G-H3F3-D11	140G-H3F4-D11	140G-H6F3-D11	140G-H6F4-D11
125	87...125	625...1250	140G-H2F3-D12	140G-H2F4-D12	140G-H3F3-D12	140G-H3F4-D12	140G-H6F3-D12	140G-H6F4-D12
160★	112...160	800...1600	140G-H2F3-D16	140G-H2F4-D16	140G-H3F3-D16	140G-H3F4-D16	140G-H6F3-D16	140G-H6F4-D16

★ IEC only.

Rated Current I_n [A]	Thermal Trip [A] $I_r = I_n$	Magnetic Trip [A] I_m	Interrupting Code H0		Interrupting Code H15	
			Cat. No.		Cat. No.	
			3 Poles	4 Poles	3 Poles	4 Poles
15	15	400	140G-H0C3-C15	140G-H0C4-C15	140G-H15C3-C15	140G-H15C4-C15
16	16	400	140G-H0C3-C16	140G-H0C4-C16	140G-H15C3-C16	140G-H15C4-C16
20	20	400	140G-H0C3-C20	140G-H0C4-C20	140G-H15C3-C20	140G-H15C4-C20
25	25	400	140G-H0C3-C25	140G-H0C4-C25	140G-H15C3-C25	140G-H15C4-C25
30	30	400	140G-H0C3-C30	140G-H0C4-C30	140G-H15C3-C30	140G-H15C4-C30
32	32	400	140G-H0C3-C32	140G-H0C4-C32	140G-H15C3-C32	140G-H15C4-C32
35	35	400	140G-H0C3-C35	140G-H0C4-C35	140G-H15C3-C35	140G-H15C4-C35
40	40	400	140G-H0C3-C40	140G-H0C4-C40	140G-H15C3-C40	140G-H15C4-C40
50	50	500	140G-H0C3-C50	140G-H0C4-C50	140G-H15C3-C50	140G-H15C4-C50
60	60	600	140G-H0C3-C60	140G-H0C4-C60	140G-H15C3-C60	140G-H15C4-C60
63	63	630	140G-H0C3-C63	140G-H0C4-C63	140G-H15C3-C63	140G-H15C4-C63
70	70	700	140G-H0C3-C70	140G-H0C4-C70	140G-H15C3-C70	140G-H15C4-C70
80	56...80	400...800	140G-H0F3-C80	140G-H0F4-C80	140G-H15F3-C80	140G-H15F4-C80
90	63...90	450...900	140G-H0F3-C90	140G-H0F4-C90	140G-H15F3-C90	140G-H15F4-C90
100	70...100	500...1000	140G-H0F3-D10	140G-H0F4-D10	140G-H15F3-D10	140G-H15F4-D10
110	77...110	550...1100	140G-H0F3-D11	140G-H0F4-D11	140G-H15F3-D11	140G-H15F4-D11
125	84...120	625...1250	140G-H0F3-D12	140G-H0F4-D12	140G-H15F3-D12	140G-H15F4-D12
160★	112...160	800...1600	140G-H0F3-D16	140G-H0F4-D16	140G-H15F3-D16	140G-H15F4-D16

★ IEC only.

Interrupting Rating/Breaking Capacity — Electronic Circuit Breakers

Interrupting Rating (50/60 Hz), UL 489/CSA C22.2-5, No. 5-02 [kA]			Breaking Capacity (50/60 Hz), IEC 60947-2								Breaking Capacity (DC), IEC 60947-2				Interrupting Code†
240V	480V	600V	220V★		415V		440V★		690V		250V DC (2-pole in series)		500V DC (3-pole in series)		
			I_{cu} [kA]	I_{cs} [% I_{cu}]	I_{cu} [kA]	I_{cs} [% I_{cu}]	I_{cu} [kA]	I_{cs} [% I_{cu}]	I_{cu} [kA]	I_{cs} [% I_{cu}]	I_{cu} [kA]	I_{cs} [% I_{cu}]	I_{cu} [kA]	I_{cs} [% I_{cu}]	
65	25	14	65	100	36	100	36	100	10	100	36	100	36	100	H2
100	35	18	85	100	50	100	50	100	12	100	50	100	50	100	H3
150	65	25	100	100	70	100	65	100	15	100	70	100	70	100	H6
200	100	35	150	100	120	100	100	100	18	75	85	100	85	100	H0
200	150	42	200	100	150	100	150	100	20	75	100	100	100	100	H15

★ These ratings have not been tested for the CCC listing.

† See table below for Cat. No. selection

Electronic LSI (Long, Short, Instantaneous)

Rated Current I_n [A]	Protection Type						Interrupting Code H2		Interrupting Code H3	
	L		S		I		Cat. No.		Cat. No.	
	$I_1=0.4...1 \times I_n$	$t_1=sec.$	$I_2=1...10 \times I_n$	$t_2=sec.$	$I_3=1...10 \times I_n$		3 Poles	4 Poles	3 Poles	4 Poles
25	10...25	3, 12, 36, 60	25...250	0.05, 0.1, 0.2, 0.4	25...250	140G-H2H3-C25	140G-H2H4-C25	140G-H3H3-C25	140G-H3H4-C25	
60	24...60	3, 12, 36, 60	60...600	0.05, 0.1, 0.2, 0.4	60...600	140G-H2H3-C60	140G-H2H4-C60	140G-H3H3-C60	140G-H3H4-C60	
100	40...100	3, 12, 36, 60	100...1000	0.05, 0.1, 0.2, 0.4	100...1000	140G-H2H3-D10	140G-H2H4-D10	140G-H3H3-D10	140G-H3H4-D10	
125	50...125	3, 12, 36, 60	125...1250	0.05, 0.1, 0.2, 0.4	125...1250	140G-H2H3-D12	140G-H2H4-D12	140G-H3H3-D12	140G-H3H4-D12	
160★	64...160	3, 12, 36, 60	160...1600	0.05, 0.1, 0.2, 0.4	160...1600	140G-H2H3-D16	140G-H2H4-D16	140G-H3H3-D16	140G-H3H4-D16	

★ IEC only.

Rated Current I_n [A]	Protection Type						Interrupting Code H6	
	L		S		I		Cat. No.	
	$I_1=0.4...1 \times I_n$	$t_1=sec.$	$I_2=1...10 \times I_n$	$t_2=sec.$	$I_3=1...10 \times I_n$	3 Poles	4 Poles	
25	10...25	3, 12, 36, 60	25...250	0.05, 0.1, 0.2, 0.4	25...250	140G-H6H3-C25	140G-H6H4-C25	
60	24...60	3, 12, 36, 60	60...600	0.05, 0.1, 0.2, 0.4	60...600	140G-H6H3-C60	140G-H6H4-C60	
100	40...100	3, 12, 36, 60	100...1000	0.05, 0.1, 0.2, 0.4	100...1000	140G-H6H3-D10	140G-H6H4-D10	
125	50...125	3, 12, 36, 60	125...1250	0.05, 0.1, 0.2, 0.4	125...1250	140G-H6H3-D12	140G-H6H4-D12	
160★	64...160	3, 12, 36, 60	160...1600	0.05, 0.1, 0.2, 0.4	160...1600	140G-H6H3-D16	140G-H6H4-D16	

★ IEC only.

Rated Current I_n [A]	Protection Type						Interrupting Code H0		Interrupting Code H15	
	L		S		I		Cat. No.		Cat. No.	
	$I_1=0.4...1 \times I_n$	$t_1=sec.$	$I_2=1...10 \times I_n$	$t_2=sec.$	$I_3=1...10 \times I_n$	3 Poles	4 Poles	3 Poles	4 Poles	
25	10...25	3, 12, 36, 60	25...250	0.05, 0.1, 0.2, 0.4	25...250	140G-H0H3-C25	140G-H0H4-C25	140G-H15H3-C25	140G-H15H4-C25	
60	24...60	3, 12, 36, 60	60...600	0.05, 0.1, 0.2, 0.4	60...600	140G-H0H3-C60	140G-H0H4-C60	140G-H15H3-C60	140G-H15H4-C60	
100	40...100	3, 12, 36, 60	100...1000	0.05, 0.1, 0.2, 0.4	100...1000	140G-H0H3-D10	140G-H0H4-D10	140G-H15H3-D10	140G-H15H4-D10	
125	50...125	3, 12, 36, 60	125...1250	0.05, 0.1, 0.2, 0.4	125...1250	140G-H0H3-D12	140G-H0H4-D12	140G-H15H3-D12	140G-H15H4-D12	
160★	64...160	3, 12, 36, 60	160...1600	0.05, 0.1, 0.2, 0.4	160...1600	140G-H0H3-D16	140G-H0H4-D16	140G-H15H3-D16	140G-H15H4-D16	

★ IEC only.

Molded Case Circuit Breakers

Product Selection — 125 A, H-Frame

Electronic LSIG (Long, Short, Instantaneous, Ground Fault)

Rated Current I_n [A]	Protection Type							Interrupting Code H2		Interrupting Code H3	
	L		S		I	G		Cat. No.		Cat. No.	
	$I_1=0.4...1 \times I_n$	$t_1=sec.$	$I_2=1...10 \times I_n$	$t_2=sec.$	$I_3=1...10 \times I_n$	$I_4=0.2...1 \times I_n$	$t_4=sec.$	3 Poles	4 Poles	3 Poles	4 Poles
25	10...25	3, 12, 36, 60	25...250	0.05, 0.1, 0.2, 0.4	25...250	5...25	0.1, 0.2, 0.4, 0.8	140G-H2I3-C25	140G-H2I4-C25	140G-H3I3-C25	140G-H3I4-C25
60	24...60	3, 12, 36, 60	60...600	0.05, 0.1, 0.2, 0.4	60...600	12...60	0.1, 0.2, 0.4, 0.8	140G-H2I3-C60	140G-H2I4-C60	140G-H3I3-C60	140G-H3I4-C60
100	40...100	3, 12, 36, 60	100...1000	0.05, 0.1, 0.2, 0.4	100...1000	20...100	0.1, 0.2, 0.4, 0.8	140G-H2I3-D10	140G-H2I4-D10	140G-H3I3-D10	140G-H3I4-D10
125	50...125	3, 12, 36, 60	125...1250	0.05, 0.1, 0.2, 0.4	125...1250	25...125	0.1, 0.2, 0.4, 0.8	140G-H2I3-D12	140G-H2I4-D12	140G-H3I3-D12	140G-H3I4-D12
160★	64...160	3, 12, 36, 60	160...1600	0.05, 0.1, 0.2, 0.4	160...1600	32...160	0.1, 0.2, 0.4, 0.8	140G-H2I3-D16	140G-H2I4-D16	140G-H3I3-D16	140G-H3I4-D16

★ IEC only.

Rated Current I_n [A]	Protection Type							Interrupting Code H6	
	L		S		I	G		Cat. No.	Cat. No.
	$I_1=0.4...1 \times I_n$	$t_1=sec.$	$I_2=1...10 \times I_n$	$t_2=sec.$	$I_3=1...10 \times I_n$	$I_4=0.2...1 \times I_n$	$t_4=sec.$	3 Poles	4 Poles
25	10...25	3, 12, 36, 60	25...250	0.05, 0.1, 0.2, 0.4	25...250	5...25	0.1, 0.2, 0.4, 0.8	140G-H6I3-C25	140G-H6I4-C25
60	24...60	3, 12, 36, 60	60...600	0.05, 0.1, 0.2, 0.4	60...600	12...60	0.1, 0.2, 0.4, 0.8	140G-H6I3-C60	140G-H6I4-C60
100	40...100	3, 12, 36, 60	100...1000	0.05, 0.1, 0.2, 0.4	100...1000	20...100	0.1, 0.2, 0.4, 0.8	140G-H6I3-D10	140G-H6I4-D10
125	50...125	3, 12, 36, 60	125...1250	0.05, 0.1, 0.2, 0.4	125...1250	25...125	0.1, 0.2, 0.4, 0.8	140G-H6I3-D12	140G-H6I4-D12
160★	64...160	3, 12, 36, 60	160...1600	0.05, 0.1, 0.2, 0.4	160...1600	32...160	0.1, 0.2, 0.4, 0.8	140G-H6I3-D16	140G-H6I4-D16

★ IEC only.

Rated Current I_n [A]	Protection Type							Interrupting Code H0		Interrupting Code H15	
	L		S		I	G		Cat. No.		Cat. No.	
	$I_1=0.4...1 \times I_n$	$t_1=sec.$	$I_2=1...10 \times I_n$	$t_2=sec.$	$I_3=1...10 \times I_n$	$I_4=0.2...1 \times I_n$	$t_4=sec.$	3 Poles	4 Poles	3 Poles	4 Poles
25	10...25	3, 12, 36, 60	25...250	0.05, 0.1, 0.2, 0.4	25...250	5...25	0.1, 0.2, 0.4, 0.8	140G-H0I3-C25	140G-H0I4-C25	140G-H15I3-C25	140G-H15I4-C25
60	24...60	3, 12, 36, 60	60...600	0.05, 0.1, 0.2, 0.4	60...600	12...60	0.1, 0.2, 0.4, 0.8	140G-H0I3-C60	140G-H0I4-C60	140G-H15I3-C60	140G-H15I4-C60
100	40...100	3, 12, 36, 60	100...1000	0.05, 0.1, 0.2, 0.4	100...1000	20...100	0.1, 0.2, 0.4, 0.8	140G-H0I3-D10	140G-H0I4-D10	140G-H15I3-D10	140G-H15I4-D10
125	50...125	3, 12, 36, 60	125...1250	0.05, 0.1, 0.2, 0.4	125...1250	25...125	0.1, 0.2, 0.4, 0.8	140G-H0I3-D12	140G-H0I4-D12	140G-H15I3-D12	140G-H15I4-D12
160★	64...160	3, 12, 36, 60	160...1600	0.05, 0.1, 0.2, 0.4	160...1600	32...160	0.1, 0.2, 0.4, 0.8	140G-H0I3-D16	140G-H0I4-D16	140G-H15I3-D16	140G-H15I4-D16

★ IEC only.

Molded Case Switch — UL489§

Rated Current I_n [A]	Magnetic Trip [A] I_m	Cat. No.	
		3 Poles	4 Poles
125	1250	140G-H6S3-D12	140G-H6S4-D12

§ Does not provide overcurrent protection; may open above 1250 A.



Bulletin 140G
Molded Case Circuit Breakers
Accessories

Accessories Table of Contents

Description	Page	Description	Page
Internal Electrical Accessories			
Auxiliary/Alarm Contact (AX/AL).....	50	Undervoltage Release (UVR)	53
Shunt Trip (SNT).....	52	Residual Current Release Module.....	53
Shunt Close (SNC).....	52	Current Transformer for Neutral Current	54
Mechanical Accessories			
Terminal Lugs.....	54	Terminal Covers	56
Extended Terminals.....	55	Variable Depth Rotary Operating Kits	58
Spreader Terminals.....	55	Flex Cable Operators.....	59
Rear Terminals.....	56	Direct Rotary Operators.....	60
Phase Barriers	56	Motor Operators	60

Bulletin 1494V Variable Depth Flange-Mounted Circuit Breaker Operating Mechanism

Components	61	Replacement Parts	63
Additional Accessories	62		

Internal Electrical Accessories

Auxiliary/Alarm Contact (AX/AL)

Auxiliary and alarm contacts are supplied in multiple variations for customer application.

- Auxiliary Contacts (AX) : Indicate ON/OFF status of the MCCB.
- Alarm Contacts (AL): Indicate trip status of the MCCB. Alarm trip can be initiated by pressing the test button on the molded case circuit breaker, a trip due to overcurrent, short circuit; or trip due to residual current, shunt, or undervoltage release signals.
- Thermal Trip Contacts (TU): Trips only when the MCCB has detected an overcurrent, short-circuit, or protection trip. H- and J-Frame MCCBs have a button to test this feature. Available only for H, J, N, NS, and R frames.

These contacts are installed by removing the MCCB cover and accessing right-side pockets within the breaker with snap-in mounting provisions. Frames G...M are supplied with pig tail wiring, with each terminal wire marked. Frames N, NS, and R are wired internal to the breaker and are terminated for connection using a 3-pin quick connector.

Description	Designation	Diagram	Frame Size	Cat. No.
(1) TU Alarm Contact 250V	TU AL	C	H, J	140G-H-EA1TA
(1) Auxiliary (1) Alarm Contact 250V	AX2/AL1	D	G, H, I, J	140G-G-EA1R1A
(2) Auxiliary (1) Alarm Contact 250V	AX1/AX2/AL1	E	G, H, I, J	140G-G-EA2R1A
(3) Auxiliary (1) Alarm Contact 250V	AX1/AX2/AX3/AL1	F	H, I, J	140G-H-EA3R1A
(3) Auxiliary (2) Alarm Contact 250V	AX1/AX2/AX3/AL1/AL2	G	H, J	140G-H-EA3R2A
(2) Auxiliary (2) Alarm (1) TU AL Contact 250V	AX2/AX3/AL1/AL2/TU AL	H	H, J	140G-H-EA2R2TA
(1) Auxiliary Contact 250V	AX2	A	G, H, I, J	140G-G-EA1A
(1) Auxiliary Contact 250V or (1) Alarm Contact 250V	AX2	A	G, H, I, J	140G-G-EA1AU★
	AL1	B		
(1) Auxiliary Contact 24V	AX2	A	G, H, I, J	140G-G-EA1J★
(1) TU Alarm Contact 24V	TU AL	C	H, J	140G-H-EA1TJ
(1) Auxiliary (1) Alarm Contact 24V	AX2/AL1	D	G, H, I, J	140G-G-EA1R1J
(3) Auxiliary (1) Alarm Contact, 24V	AX1/AX2/AX3/AL1	F	H, I, J	140G-H-EA3R1J
(1) Auxiliary (1) Alarm Contact, 400V	AX2/AL1	D	H, J	140G-H-EA1R1B
(2) Auxiliary Contact 400V	AX1/AX2	I	H, J	140G-H-EA2B
(1) Auxiliary (1) Alarm Contact 250V	AX1/AL1	J	K, M	140G-K-EA1R1A
(3) Auxiliary (1) Alarm Contact 250V	AX1/AX2/AX3/AL1	F	K, M	140G-K-EA3R1A
(3) Auxiliary (1) Alarm Contact 24V	AX1/AX2/AX3/AL1	F	K, M	140G-K-EA3R1J
(1) Auxiliary (1) Alarm Contact 400V	AX1/AL1	J	K, M	140G-K-EA1R1B
(2) Auxiliary Contact 400V	AX1/AX2	I	K, M	140G-K-EA2B
(1) Auxiliary (1) Alarm Contact 24V	AX2/AL1	D	N	140G-N-EA1R1J
(2) Auxiliary Contact 24V	AX1/AX2	I	N, NS	140G-N-EA2J
(1) Auxiliary (1) Alarm Contact 400V	AX2/AL1	D	N	140G-N-EA1R1B
(2) Auxiliary Contact 400V	AX1/AX2	I	N, NS	140G-N-EA2B
(1) TU Alarm Contact 250V	TU AL	C	N, NS	140G-N-EA1TA
(4) Auxiliary Contact 24V	AX1/AX2/AX3/AX4	K	R	140G-R-EA4J
(4) Auxiliary Contact 400V	AX1/AX2/AX3/AX4	K	R	140G-R-EA4A
(1) TU Alarm Contact 250V	TU AL	L	R	140G-R-EA1TA



Representative Photo

★ This contact is supplied with unmarked wires. Contact can function as either an auxiliary or alarm contact, depending on connection method.

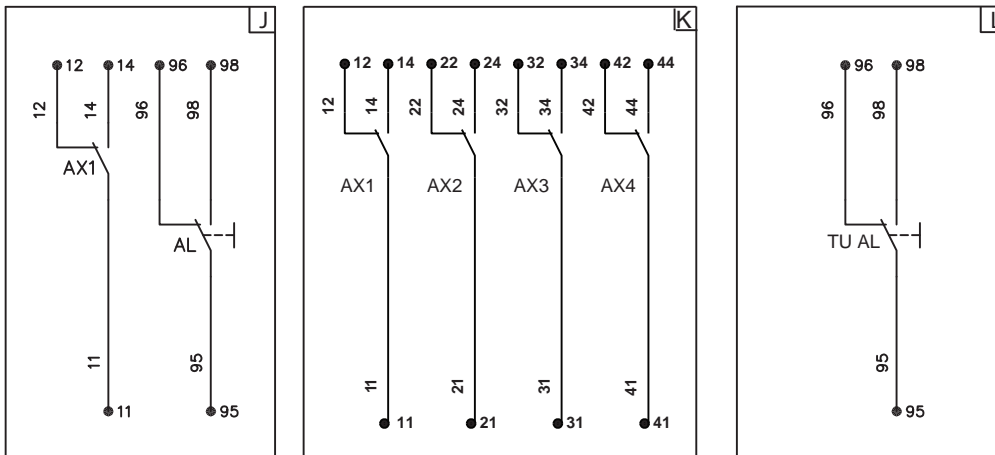
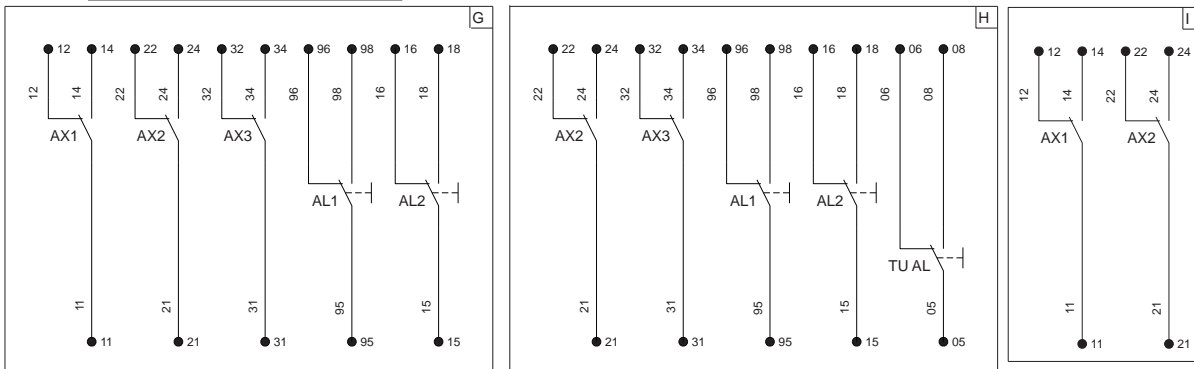
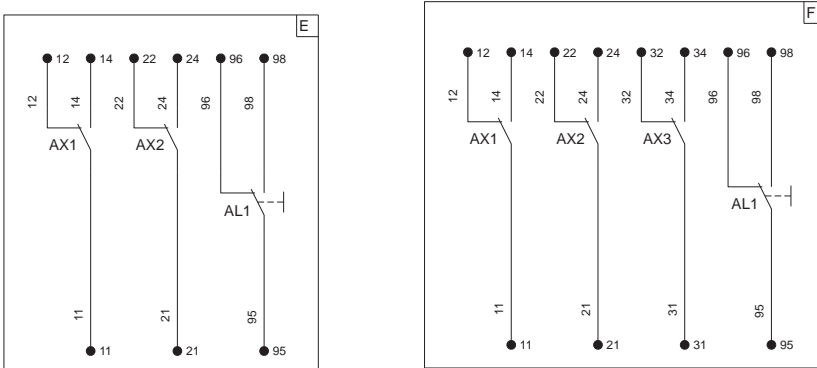
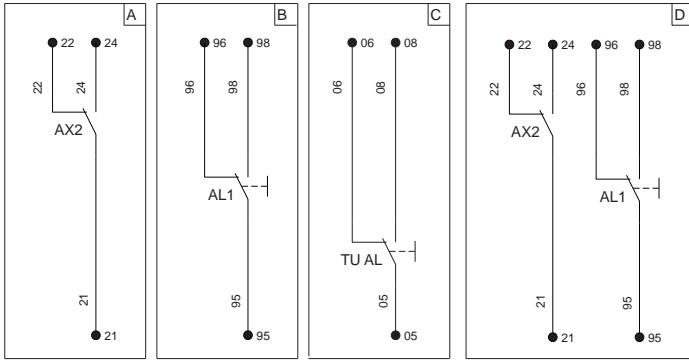

Diagrams



Bulletin 140G
Molded Case Circuit Breakers
 Accessories

Shunt Trip (SNT)

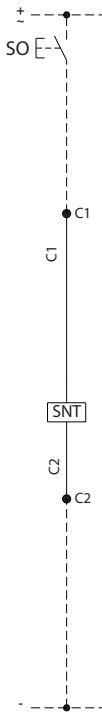
- Allows for remote tripping of the MCCB by applying control voltage to the shunt trip coil.
- Frames G, H, I, J, K, and M are supplied with pig-tail wiring (each terminal wire is marked).
- Frame N, NS, and R are wired internal to the breaker and terminated for connection using a 3-pin quick connector.

Description		Diagram	Frame Size	Cat. No.
 <p>Representative Photo</p>	12V DC		G, H, I, J	140G-G-SNR
	24...30V AC/DC			140G-G-SNJ
	48...60V AC/DC			140G-G-SNKY
	110...127V AC/110...125V DC			140G-G-SND
	220...240V AC/220...250V DC			140G-G-SNA
	380...440V AC			140G-G-SNB
 <p>Representative Photo</p>	480...525V AC		140G-G-SNC	
	12V DC		140G-K-SNR	
	24...30V AC/DC		140G-K-SNJ	
	48...60V AC/DC		140G-K-SNKY	
	110...127V AC/110...125V DC		140G-K-SND	
	220...240V AC/220...250V DC		140G-K-SNA	
 <p>Representative Photo</p>	380...440V AC		140G-K-SNB	
	480...525V AC		140G-K-SNC	
	24V AC/DC		140G-N-SNJ	
	48V AC/DC		140G-N-SNKY	
	110...120V AC/DC		140G-N-SND	
	220...240V AC/DC		140G-N-SNA	
	380...400V AC	140G-N-SNB		
	24V DC	140G-R-SNJ		
	48V AC/DC	140G-R-SNKY		
	110...120V AC/DC	140G-R-SND		
220...240V AC/DC	140G-R-SNA			
380...400V AC/DC	140G-R-SNB			

Shunt Close (SNC)



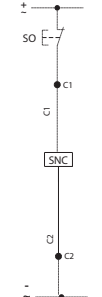

- For use with motorized versions of the NS- and R-Frame MCCB.
- Allows for remote closing of the MCCB when the spring motor is charged.

The shunt close unit is wired internal to the MCCB and terminated for connection using a 3-pin quick connect.

Description		Diagram	Frame Size	Cat. No.
 <p>Representative Photo</p>	24V AC/DC		NS	140G-NS-SNCJ
	48V AC/DC			140G-NS-SNCKY
	110...120V AC/DC			140G-NS-SNCD
	220...240V AC/DC			140G-NS-SNCA
	380...400V AC			140G-NS-SNCB
			24V DC	140G-R-SNCJ
			48V AC/DC	140G-R-SNCKY
			110...120V AC/DC	140G-R-SNCD
			220...240V AC/DC	140G-R-SNCA
			380...400V AC	140G-R-SNCB

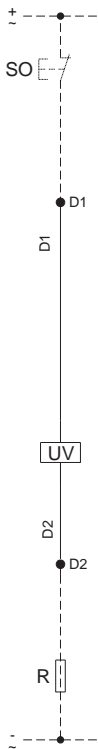
Undervoltage Release (UVR)

- Opens the MCCB when supply voltage drops below 0.7 of the UV relay, with a trip rating from 0.7...0.35.
- The MCCB can be reset when the supply voltage is higher than 0.85 of the relay rating.
- When the UV is de-energized it is not possible to close the main contacts on the MCCB.
- R Resistor is supplied with the MCCB when reset is required.

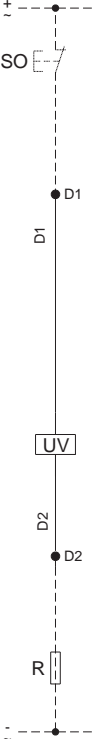
Description		Diagram	Frame Size	Cat. No.		
 <p><i>Representative Photo</i></p>	24...30V AC/DC		G, H, I, J	140G-G-UVJ		
	48V AC/DC			140G-G-UVR		
	60V AC/DC			140G-G-UVKY		
	110...127V AC/110...125V DC			140G-G-UVD		
	220...240V AC/220...250V DC			140G-G-UVA		
	380...440 V AC			140G-G-UVB		
 <p><i>Representative Photo</i></p>	480...525 V AC			K, M	140G-G-UVC	
	24...30V AC/DC				140G-K-UVJ	
	48V AC/DC				140G-K-UVR	
	60V AC/DC				140G-K-UVKY	
	110...127V AC/110...125V DC				140G-K-UVD	
	220...240V AC/220...250V DC				140G-K-UVA	
380...440 V AC	140G-K-UVB					
 <p><i>Representative Photo</i></p>	480...525 V AC				N, NS	140G-K-UVC
	24V AC/DC					140G-N-UVJ
	60V AC/DC					140G-N-UVKY
	110...120V AC/DC					140G-N-UVD
	220...240V AC/DC					140G-N-UVA
	380...400V AC	140G-N-UVB				
	415...440V AC	140G-N-UVC				
	R	24V DC			140G-R-UVJ	
		60V AC/DC			140G-R-UVKY	
		110...120V AC/DC			140G-R-UVD	
		220...240V AC/DC			140G-R-UVA	
		380...400V AC	140G-R-UVB			
440...480V AC		140G-R-UVC				

Residual Current Release Module (IEC Only)

The residual current release module provides protection against low levels of earth (ground) fault currents. It continuously monitors the state of the insulation, with adjustability to provide protection from direct and indirect contact. Compliant with IEC 60947-2 annex B, IEC 61000 for protection against unwarranted tripping.

- Alarm & Trip indication
- 0.03 A with 0.0 s override
- Current adjustment: 0.5...10 A
- Time adjustment: 0.0...3 s
- Test

 <p><i>Representative Photo</i></p>	Frame Size	3-Pole Cat. No.	4-Pole Cat. No.
	G	140G-G-ELP1603	140G-G-ELP1604
	H	—	140G-H-ELP1604
	I	140G-I-ELP2503	140G-I-ELP2504
	J	—	140G-J-EP2504
	K	—	140G-K-ELP

Molded Case Circuit Breakers

Accessories

Current Transformer for Neutral Current



Representative Photo

Rated Current [A]	Frame Size	Cat. No.
300	K ★	140G-K-NCTD30
400	K ★	140G-K-NCTD40
600	M ★	140G-M-NCTD60
800	M ★	140G-M-NCTD80
400...1600	N, NS	140G-N-NCTE16
1000...3200	R	140G-R-NCTE30

★ Order with connector (Cat. No. 140G-K-CC).

Mechanical Accessories

Terminal Lugs



Description	Frame Size	Cat. No. (Pkg. Qty. 3)	Cat. No. (Pkg. Qty. 4)	
<p>Representative Photo</p>	G	Cu wire, MCCB only (1) 14...1/0 AWG or 2.5...70 mm ²	140G-G-TLC13	140G-G-TLC14
		Cu wire, MCP only (1) 14...1/0 AWG or 1.5...70 mm ²	140G-G-TLC13A	—
		Multiple cable - Cu wire (6) 14...2 AWG or 2.5...35 mm ²	140G-G-MTL63	140G-G-MTL64
		Cu wire only (1) 14...1/0 AWG or 2.5...95 mm ²	140G-H-TLC13	140G-H-TLC14
<p>Representative Photo</p>	H	Multiple cable - Cu wire (6) 14...2 AWG or 2.5...35 mm ²	140G-H-MTL63	140G-H-MTL64
		Al or Cu wire (1) 14...1/0 AWG or 2.5...50 mm ²	140G-I-TLA13	140G-I-TLA14
		Al or Cu wire (1) 4...300 MCM or 25...150 mm ²	140G-I-TLA1A3	140G-I-TLA1A4
		Cu wire only (1) 10...250 MCM or 6...185 mm ²	140G-I-TLC13	140G-I-TLC14
<p>Representative Photo</p>	I	Multiple cable - Cu wire (6) 12...2 AWG or 2.5...35 mm ²	140G-I-MTL63	140G-I-MTL64
		Al or Cu wire (1) 14...1/0 AWG or 2.5...50 mm ²	140G-J-TLA13	140G-J-TLA14
		Al or Cu wire (1) 4...300 MCM or 25...150 mm ²	140G-J-TLA1A3	140G-J-TLA1A4
		Al or Cu wire (1) 6 (Al)/10 (Cu)...350 MCM or 2.5...185 mm ² (Al)	140G-J-TLA1B3	140G-J-TLA1B4
		Cu wire only (1) 10...350 MCM or 6...185 mm ²	140G-J-TLC13	140G-J-TLC14
<p>Representative Photo</p>	J	Multiple cable - Cu wire (6) 12...2 AWG or 2.5...35 mm ²	140G-J-MTL63	140G-J-MTL64
		Al or Cu wire (1) 250...500 MCM or 120...240 mm ²	140G-K-TLA13	140G-K-TLA14
		Al or Cu wire (2) 2/0...250 MCM or 95...120 mm ²	140G-K-TLA23	140G-K-TLA24
		Cu wire only (1) 250...500 MCM or 120...240 mm ²	140G-K-TLC13	140G-K-TLC14
		Cu wire only (2) 2/0...250 MCM or 95...120 mm ²	140G-K-TLC23	140G-K-TLC24
<p>Representative Photo</p>	K	Multiple cable - Cu wire (6) 6...1/0 AWG or 16...50 mm ²	140G-K-MTL63	140G-K-MTL64
		Al or Cu wire (2) 250...500 MCM or 120...240 mm ²	140G-M-TLA23	140G-M-TLA24
		Al or Cu wire (3) 2/0...400 MCM or 70...185 mm ²	140G-M-TLA33	140G-M-TLA34
		Cu wire only (2) 3/0...350 MCM or 85...185 mm ²	140G-M-TLC23	140G-M-TLC24
		Cu wire only (3) 2/0...350 MCM or 70...185 mm ²	140G-M-TLC33	140G-M-TLC34
<p>Representative Photo</p>	M	Al or Cu wire (4) 4/0...500 MCM or 70...240 mm ²	140G-N-TLA43	140G-N-TLA44
		Cu wire only (4) 4/0...500 MCM or 70...240 mm ²	140G-N-TLC43	140G-N-TLC44
		Al or Cu wire (6) 1/0...750 MCM or 50...400 mm ²	140G-R-TLA63	—
		Cu wire only (6) 1/0...750 MCM or 50...400 mm ²	140G-R-TLC63	—
<p>Representative Photo</p>	N, NS			
		R		
		R		



Extended Terminals

 Representative Photo	Description	Frame Size	3-Pole Cat. No. (Pkg. Qty. 3)	4-Pole Cat. No. (Pkg. Qty. 4)
	Extended Terminals for busbar or ring type connection <ul style="list-style-type: none"> • G- & I-frame supplied with 100 mm phase barrier • H- & J-frame supplied with insulator, 100 mm phase barrier, and terminal cover • K- & N-/NS-frame supplied with insulator and 100 mm phase barrier • M-frame terminals only 	G	140G-G-EXT3	140G-G-EXT4
		H	140G-H-EXT3	140G-H-EXT4
		I	140G-I-EXT3	140G-I-EXT4
		J	140G-J-EXT3	140G-J-EXT4
		K	140G-K-EXT3	140G-K-EXT4
		M	140G-M-EXT3	140G-M-EXT4
		N, NS	140G-N-EXT3	140G-N-EXT4

Spreader Terminals

 Representative Photo	Description	Frame Size	3-Pole Cat. No. (Pkg. Qty. 3)	4-Pole Cat. No. (Pkg. Qty. 4)
	Spreader Terminals for busbar or ring type connection <ul style="list-style-type: none"> • G- & I-frame supplied with 200 mm phase barrier • H- & J-frame supplied with insulator, 100 mm phase barrier, and terminal cover • K- & N-/NS-frame supplied with insulator and 100 mm phase barrier • M- & R-frame terminals only 	G	140G-G-EXS3	140G-G-EXS4
		H	140G-H-EXS3	140G-H-EXS4
		I	140G-I-EXS3	140G-I-EXS4
		J	140G-J-EXS3	140G-J-EXS4
		K	140G-K-EXS3	140G-K-EXS4
		M	—	140G-M-EXS4
		N, NS	—	140G-N-EXS4
		R	140G-R-EXS3	140G-R-EXS4
 Representative Photo	Top Spreader Terminals for busbar or ring type connection <ul style="list-style-type: none"> • M-frame terminals only 	M	140G-M-EXSLI3	—
		N, NS	140G-N-EXSLI3	—
	Bottom Spreader Terminals for busbar or ring type connection <ul style="list-style-type: none"> • N-/NS-frame supplied with insulator and 100 mm phase barrier 	M	140G-M-EXSLO3	—
		N, NS	140G-N-EXSLO3	—

Rear Terminals

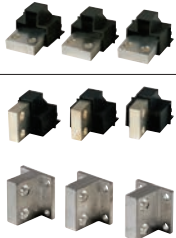
 Representative Photo	Description	Frame Size	3-Pole Cat. No. (Pkg. Qty. 3)	4-Pole Cat. No. (Pkg. Qty. 4)
	Rear flat horizontal terminals	N, NS	140G-N-TLH3	140G-N-TLH4
Rear flat vertical terminals	N, NS	140G-N-TLV3	140G-N-TLV4	
	R ★	140G-R-TLV3	140G-R-TLV4	

★ 2000 A and 2500 A MCCBs only.

Bulletin 140G
Molded Case Circuit Breakers
 Accessories

Phase Barriers

- Provides additional clearance when special connections that extend beyond the frame of the MCCB are used.
- Frames G, H, I, J, and K are supplied with 25 mm barriers as standard.

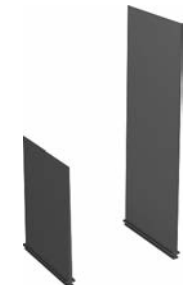
 <i>Representative Photo</i>	Frame Size	Length	3-Pole Cat. No. (Pkg. Qty. 4)	4-Pole Cat. No. (Pkg. Qty. 6)
	G, I		1 in. (25 mm)	140G-G-PB3M
4 in. (100 mm)			140G-G-PB3L	140G-G-PB4L
8 in. (200 mm)			140G-G-PB3H	140G-G-PB4H
H, J		1 in. (25 mm)	140G-H-PB3M	140G-H-PB4M
		4 in. (100 mm)	140G-H-PB3L	140G-H-PB4L
		8 in. (200 mm)	140G-H-PB3H	140G-H-PB4H
K, N, NS		4 in. (100 mm)	140G-K-PB3L	140G-K-PB4L
		8 in. (200 mm)	140G-K-PB3H	140G-K-PB4H
M		4 in. (100 mm)	140G-M-PB3L	140G-M-PB4L
R		4 in. (100 mm)	140G-R-PB3L	140G-R-PB4L
		8 in. (200 mm)	140G-R-PB3H	140G-R-PB4H

Terminal Covers

- Provide IP40 finger protection against accidental contact with live parts.
- Terminal covers are pre-punched to ease installation.
- Supplied as standard with the selection of multiple cable terminal lugs.

 <i>Representative Photo</i>	Frame Size	Height	3-Pole Cat. No. (Pkg. Qty. 2)	4-Pole Cat. No. (Pkg. Qty. 2)
	G		0.08 in. (2 mm)	140G-G-TC3L
2 in. (50 mm)			140G-G-TC3H	140G-G-TC4H
H		0.08 in. (2 mm)	140G-H-TC3L	140G-H-TC4L
		2 in. (50 mm)	140G-H-TC3H	140G-H-TC4H
I		0.08 in. (2 mm)	140G-I-TC3L	140G-I-TC4L
		2.36 in. (60 mm)	140G-I-TC3H	140G-I-TC4H
J		0.08 in. (2 mm)	140G-J-TC3L	140G-J-TC4L
		2.36 in. (60 mm)	140G-J-TC3H	140G-J-TC4H
K		0.08 in. (2 mm)	140G-K-TC3L	140G-K-TC4L
		2.36 in. (60 mm)	140G-K-TC3H	140G-K-TC4H
M		0.08 in. (2 mm)	140G-M-TC3L	140G-M-TC4L
		2.36 in. (60 mm)	140G-M-TC3H	140G-M-TC4H
N, NS		0.1 in. (2.5 mm)	140G-N-TC3L	140G-N-TC4L
		2.76 in. (70 mm)	140G-N-TC3H	140G-N-TC4H

Variable Depth Rotary Operating Kits

Rotary, Variable Depth Operators

- Supplied with external handle, operating shaft, and MCCB mounted operating mechanism.
- Refer to page 56 to select as components.
- Frames G, H, I, and J use a Bul. 140U P-style handle.
- Frames K, M, and N use a Bul. 140U medium style handle.

	Frame Size	Handle Color	Shaft Length	Cat. No.
 Representative Photo	G, I	Black	12 in. (30.48 mm)	140G-G-RVM12B
		Red/Yellow		140G-G-RVM12R
		Black	21 in. (53.34 mm)	140G-G-RVM21B
		Red/yellow		140G-G-RVM21R
	H, J	Black	12 in. (30.48 mm)	140G-H-RVM12B
		Red/yellow		140G-H-RVM12R
		Black	21 in. (53.34 mm)	140G-H-RVM21B
		Red/yellow		140G-H-RVM21R
 Representative Photo	K	Black	12.6 in. (320 mm)	140G-K-RVM12B
		Red/yellow		140G-K-RVM12R
		Black	22.8 in. (580 mm)	140G-K-RVM21B
		Red/yellow		140G-K-RVM21R
	M	Black	12.6 in. (320 mm)	140G-M-RVM12B
		Red/yellow		140G-M-RVM12R
		Black	22.8 in. (580 mm)	140G-M-RVM21B
		Red/yellow		140G-M-RVM21R
	N	Black	12.6 in. (320 mm)	140G-N-RVM12B
		Red/yellow		140G-N-RVM12R
		Black	22.8 in. (580 mm)	140G-N-RVM21B
		Red/yellow		140G-N-RVM21R

Rotary, Variable Depth Operators with Internal NFPA 79 Operating Handle

- Supplied with external handle, NFPA handle with operating shaft, support bracket, and MCCB mounted operating mechanism.
- Refer to page 58 to select as components.
- Frames G, H, I, and J use a Bul. 140U P-style handle.
- Frames K, M, and N use a Bul. 140U medium style handle.

	Frame Size	Handle Color	Shaft Length	Cat. No.
 Representative Photo	G, I	Black	12 in. (30.48 mm)	140G-G-NVM12B
		Red/yellow		140G-G-NVM12R
		Black	21 in. (53.34 mm)	140G-G-NVM21B
		Red/yellow		140G-G-NVM21R
	H, J	Black	12 in. (30.48 mm)	140G-H-NVM12B
		Red/yellow		140G-H-NVM12R
		Black	21 in. (53.34 mm)	140G-H-NVM21B
		Red/yellow		140G-H-NVM21R
 Representative Photo	K	Black	12.6 in. (320 mm)	140G-K-NVM12B
		Red/yellow		140G-K-NVM12R
		Black	22.8 in. (580 mm)	140G-K-NVM21B
		Red/yellow		140G-K-NVM21R
	M	Black	12.6 in. (320 mm)	140G-M-NVM12B
		Red/yellow		140G-M-NVM12R
		Black	22.8 in. (580 mm)	140G-M-NVM21B
		Red/yellow		140G-M-NVM21R
	N	Black	12.6 in. (320 mm)	140G-N-NVM12B
		Red/yellow		140G-N-NVM12R
		Black	22.8 in. (580 mm)	140G-N-NVM21B
		Red/yellow		140G-N-NVM21R

Molded Case Circuit Breakers

Accessories

Variable Depth Rotary Components

 Representative Photo	Description	Handle Color	Frame Size	Cat. No.	
	<ul style="list-style-type: none"> • P-style handle for G, H, I, and J frames • Medium handles for K, M, and N frames • Rated 3/3R/4/4X/12 • Accepts 3 padlocks 		Black/Grey	G, H, I, J	140U-PB
			Red/Yellow		140U-PY
			Black/Grey	K, M, N	140U-HM4
			Red/Yellow		140U-HM4E

 Representative Photo	Description	Shaft Length	Frame Size	Cat. No.	
	Extension Shaft		12 in. (305 mm)	G, H, I, J	194R-S1
			21 in. (533 mm)		194R-S2
			12 in. (305 mm)	K, M, N	140U-R5
			21 in. (533 mm)		140U-R6

 Representative Photo	Description	Shaft Length	Frame Size	Cat. No.	
	NFPA 79 internal operating handle with shaft Internal handle permits operation of the molded case circuit breaker when the door is open in compliance with NFPA 79.		12 in. (305 mm)	G, H, I, J	140G-N1
			21 in. (533 mm)		140G-N2
			12 in. (305 mm)	K, M, N	140G-N7
			21 in. (533 mm)		140G-N8

 Representative Photo	Description	Frame Size	Cat. No.
	Rotary, Variable Depth Operating Mechanism <ul style="list-style-type: none"> • Direct molded case circuit breaker mount • G, H, I, and J frame use 194R-S1 or 194R-S2 shafts (140G-N1 or 140G-N2 NFPA) • K, M, and N frames use 194R-R7 or 194R-R8 shafts (140G-R7 or 140G-R8 NFPA) • Shaft secured with set screw or cotter pin 	G, I	140G-G-RMX
		H, J	140G-H-RMX
		K	140G-K-RMX
		M	140G-M-RMX
		N	140G-N-RMX

Description	Frame Size	Cat. No.
Support Bracket Supplied as standard with NFPA variable depth operator kits	G, H, I, J	140G-G-OSB
	K	140G-K-OSB
	M	140G-M-OSB
	N	140G-N-OSB

Auxiliary Contacts for Handle Mechanism Mounting



Suitable for:

- 140G-G-RMB, -RMY, RMX
- 140G-H-RMB, -RMY, RMX
- 140G-K-RMB, -RMY, RMX
- 140G-M-RMB, -RMY, RMX

 Representative Photo	Description	Pkg. Qty	Frame Size	Cat. No.
	Early Make Handle Auxiliary Contact Open 400V	2	G, H, I, J	140G-G-EAM1B
	Early Break Handle Auxiliary Contact Close 400V	2		140G-G-EAB1B
	Early Make Handle Auxiliary Contact Close 250V	2	K	140G-K-EAM1A
M			140G-M-EAM1A	

Direct Rotary Operators

- Mount with direct handle operation of the MCCB.
- Lockable in OFF position (three padlocks max.).

 Representative Photo  Representative Photo	Frame Size	Handle Color	Cat. No.
	G, I	Black	140G-G-RMB
		Red/yellow	140G-G-RMY
	H, J	Black	140G-H-RMB
		Red/yellow	140G-H-RMY
	K	Black	140G-K-RMB
		Red/yellow	140G-K-RMY
	M	Black	140G-M-RMB
		Red/yellow	140G-M-RMY
	N	Black	140G-N-RMB
Red/yellow		140G-N-RMY	

Motor Operators

- Remotely opens, closes, and resets the MCCB.
- Frame G & I motor operators are supplied with auto/manual selector, test feature, and special tool for local operation of the MCCB.
- Frames H, J, K, and M utilize a stored energy motor for local control of the motor without the use of special tools and include auto/manual/lock selection, lever to recharge the motor, and open & close push button operation.

Description	Frame Size	Cat. No.
 Representative Photo	G, I	140G-G-EOPJ
		140G-G-EOPKY
		140G-G-EOPD
		140G-G-EOPA
		140G-G-EOPB
		140G-G-EOPC
 Representative Photo	H, J	140G-H-EOPJ
		140G-H-EOPKY
		140G-H-EOPD
		140G-H-EOPA
		140G-H-EOPB
		140G-H-EOPC
 Representative Photo	K	140G-K-EOPJ
		140G-K-EOPKY
		140G-K-EOPD
		140G-K-EOPA
	M	140G-M-EOPB
		140G-M-EOPJ
		140G-M-EOPKY
		140G-M-EOPD
		140G-M-EOPA
		140G-M-EOPB

Description	Frame Size	Cat. No.
 Representative Photo	NS	140G-NS-SCMA
		140G-NS-SCMB
		140G-NS-SCMD
		140G-NS-SCMJ
		140G-NS-SCMKY
	R	140G-R-SCMA
		140G-R-SCMD
		140G-R-SCMJ
		140G-R-SCMKY
		140G-R-SCMKY

Molded Case Circuit Breakers

Accessories

Flex Cable Operators

- For use with NEMA-style flange enclosures.
- Includes handle, MCCB operator, cable, and necessary hardware.
- Pre-assembled for ease of installation.



Representative Photo

Frame Size	Handle Type	Cable Length	Cat. No.
G, I	Non-metallic Handle, Type 1/3/12/4/4X	4 ft (1.3 m)	140G-G-FCX04
		6 ft (1.9 m)	140G-G-FCX06
		10 ft (3.0 m)	140G-G-FCX10
	Stainless Steel Handle, Type 4/4X	4 ft (1.3 m)	140G-G-FCS04
		6 ft (1.9 m)	140G-G-FCS06
		10 ft (3.0 m)	140G-G-FCS10
	Painted Metal Handle, Type 1/12	4 ft (1.3 m)	140G-G-FMX04
		6 ft (1.9 m)	140G-G-FMX06
		10 ft (3.0 m)	140G-G-FMX10
H	Non-metallic Handle, Type 1/3/12/4/4X	4 ft (1.3 m)	140G-H-FCX04
		6 ft (1.9 m)	140G-H-FCX06
		10 ft (3.0 m)	140G-H-FCX10
	Stainless Steel Handle, Type 4/4X	4 ft (1.3 m)	140G-H-FCS04
		6 ft (1.9 m)	140G-H-FCS06
		10 ft (3.0 m)	140G-H-FCS10
	Painted Metal Handle, Type 1/12	4 ft (1.3 m)	140G-H-FMX04
		6 ft (1.9 m)	140G-H-FMX06
		10 ft (3.0 m)	140G-H-FMX10
J	Non-metallic Handle, Type 1/3/12/4/4X	4 ft (1.3 m)	140G-J-FCX04
		6 ft (1.9 m)	140G-J-FCX06
		10 ft (3.0 m)	140G-J-FCX10
	Stainless Steel Handle, Type 4/4X	4 ft (1.3 m)	140G-J-FCS04
		6 ft (1.9 m)	140G-J-FCS06
		10 ft (3.0 m)	140G-J-FCS10
	Painted Metal Handle, Type 1/12	4 ft (1.3 m)	140G-J-FMX04
		6 ft (1.9 m)	140G-J-FMX06
		10 ft (3.0 m)	140G-J-FMX10
K	Non-metallic Handle, Type 1/3/12/4/4X	4 ft (1.3 m)	140G-K-FCX04
		6 ft (1.9 m)	140G-K-FCX06
		10 ft (3.0 m)	140G-K-FCX10
	Stainless Steel Handle, Type 4/4X	4 ft (1.3 m)	140G-K-FCS04
		6 ft (1.9 m)	140G-K-FCS06
		10 ft (3.0 m)	140G-K-FCS10
	Painted Metal Handle, Type 1/12	4 ft (1.3 m)	140G-K-FMX04
		6 ft (1.9 m)	140G-K-FMX06
		10 ft (3.0 m)	140G-K-FMX10
M	Stainless Steel Handle, Type 4/4X	4 ft (1.3 m)	140G-M-FCS04
		6 ft (1.9 m)	140G-M-FCS06
		10 ft (3.0 m)	140G-M-FCS10
	Painted Metal Handle, Type 1/12	4 ft (1.3 m)	140G-M-FMX04
		6 ft (1.9 m)	140G-M-FMX06
		10 ft (3.0 m)	140G-M-FMX10
N	Stainless Steel Handle, Type 4/4X	4 ft (1.3 m)	140G-N-FCS04
		6 ft (1.9 m)	140G-N-FCS06
		10 ft (3.0 m)	140G-N-FCS10
	Painted Metal Handle, Type 1/12	4 ft (1.3 m)	140G-N-FMX04
		6 ft (1.9 m)	140G-N-FMX06
		10 ft (3.0 m)	140G-N-FMX10

Bulletin 1494V Variable Depth Flange-Mounted Circuit Breaker Operating Mechanism



Components

Circuit Breaker Operating Mechanism

The mechanism listed must be combined with a connecting rod, operating handle, and a circuit breaker (supplied by customer) to obtain a functional device.

3-Pole Circuit Breaker★			Operating Mechanism
Brand	Frame Size [A]	Frame Designation	Cat. No.
Allen-Bradley	125, 225, 250	140G-G, H, I, J	1494V-M70
Allen-Bradley	400	140G-K	1494V-M71
Allen-Bradley	800, 1200	140G-M, N	1494V-M72

★ Circuit breakers to be provided by customer.

Connecting Rods

Approximate dimensions are in inches (millimeters). Approximate dimensions are not intended for manufacturing purposes.

Circuit Breaker Frame Size [A]	Enclosure Depth		Cat. No.
	Minimum	Maximum	
125, 150, 250, 400, 600, 800, 1200	6-3/4 (172)	9-1/8 (232)	1494V-RA3
	6-3/4 (172)	21-5/8 (549)	1494V-RA4

Operating Handle





Handle Type	Description	Circuit Breaker Frame Size [A]	Operating Handle
			Cat. No.
Type 1, 3R, 4, 4X, 12	Nonmetallic	125, 150, 250, 400	1494F-P1
Type 1, 3R, 4, 12	Painted Metal	125, 150, 250, 400	1494F-M1
Type 4, 4X	Stainless Steel	125, 150, 250, 400	1494F-S1
Type 1, 3R, 4, 12	Painted Metal	800, 1200	1494F-M2
Type 4, 4X	Stainless Steel	800, 1200	1494F-S2

Auxiliary Contacts

Description	For Use With	Contact Type	Cat. No.
Auxiliary Contact Kit for Circuit Breakers (includes contacts and adapter)	125...1200 A Allen-Bradley Bul. 140G Circuit Breakers	1 N.O.	1495-N85
		1 N.C.	1495-N86



Bulletin 140G
Molded Case Circuit Breakers
 Accessories

Additional Accessories

	Description	Frame Size	Cat. No.	
	Trip Test Unit	All	140G-ELTT	
 <i>Representative Photo</i>	Padlockable Handle Block Padlocking Hasp Lock-OFF only	G, I	140G-G-PL	
		H, J	140G-H-PL	
		N	140G-N-PL	
		NS	140G-NS-PL	
		R	140G-R-PL	
	Direct Mechanical Lock to Door	N, NS	140G-N-SINT	
	Description	Frame Size	3-Pole Cat. No.	4-Pole Cat. No.
 <i>Representative Photo</i>	Replacement Mounting Hardware Metric threads	G, I	★ 140G-G-MH3	‡ 140G-G-MH4
		H, J	—	★ 140G-H-MH4
		K	—	§ 140G-K-MH4
		M	—	§ 140G-M-MH4
		N, NS	—	§ 140G-N-MH4
		G	140G-G-DRA	140G-G-DRA4
	DIN Rail Adapter Adapts to 35 mm DIN Rail	H, J	140G-H-DRA	
 <i>Representative Photo</i>		I	140G-I-DRA	140G-I-DRA4
		G	140G-G-EP3	140G-G-EP4
 <i>Representative Photo</i>	Escutcheon Plates Finish Frame with Marking provision window. For flush mounted (to door) MCCB applications.	H	140G-H-EP3	140G-H-EP4
		I	140G-I-MH3	140G-I-MH4
		J	140G-J-MH3	140G-J-MH4
		K	140G-K-MH3	
		M	140G-M-MH3	
		N, NS	140G-N-MH3	
		R	140G-R-MH3	
	IP54 Door protection Transparent plastic cover flush mounted to the enclosure door. Mounted on hinges and provided with a keyed lock.	N, NS	140G-N-BC12	
 <i>Representative Photo</i>		R	140G-R-BC12	

- ★ Pkg. Qty. 2
- ‡ Pkg. Qty. 3
- § Pkg. Qty. 4

Replacement Parts

	Description	Frame Size	3-Pole Cat. No.	4-Pole Cat. No.
 <p><i>Representative Photo</i></p>	<p>Replacement End Cap Kits End Caps are supplied as standard for G, H, I, J, K, M, N & NS frames. Provide connections for ring type or bolt-on terminals.</p>	G	140G-G-ECM	140G-G-ECM4
		H	140G-H-ECM	140G-H-ECM4
		I	140G-I-ECM	140G-I-ECM4
		J	140G-J-ECM	140G-J-ECM4
		K	140G-K-ECM	140G-K-ECM4
		M	140G-M-ECM	140G-M-ECM4
		N	140G-N-ECM	140G-N-ECM4
		H	140G-H-BP3	140G-H-BP4
 <p><i>Representative Photo</i></p>	<p>Insulators Supplied as standard for G, H, I, J, K, and M frames. Provide insulating barrier for MCCB applications, required for all applications with a $U_e > 440V$. Pkg Qty 10.</p>	J	140G-J-BP3	140G-J-BP4
		K	140G-K-BP3	140G-K-BP4
		M	140G-M-BP3	140G-M-BP4

Bulletin 140G
Molded Case Circuit Breakers
Specifications — G- and H-Frame

		G-Frame				H-Frame†					
Max. Rated Current	[A]	125		160★		125			160★		
Rated insulation voltage, U _i , IEC	[V]	800				1000					
NEMA, UL, CSA											
Interrupting Rating Code		G2	G3	G6	G2 G3 G6	H2	H3	H6	H0	H15	H2 H3 H6 H0 H15
240V AC, 50/60Hz	[kA]	50	65	100	50 65 100	65	100	150	200	200	65 100 150 200 200
480V AC, 50/60Hz	[kA]	25	35	65	25 35 65	25	35	65	100	150	25 35 65 100 150
600Y/347V AC, 50/60Hz	[kA]	10	14	25	10 14 25	—	—	—	—	—	—
600V AC, 50/60 Hz	[kA]	—	—	—	—	14	18	25	35	42	14 18 35 35 42
IEC 60947-2											
Rated ultimate short-circuit breaking capacity, I _{cu}											
220/230/240V AC, 50/60Hz	[kA]	65	85	100	65 85 100	65	85	100	150	200	65 85 100 150 200
380V AC, 50/60Hz	[kA]	36	50	70	36 60 70	36	50	70	120	150	26 50 70 120 150
415V AC, 50/60Hz	[kA]	36	50	70	36 50 70	36	50	70	120	150	36 50 70 120 150
440V AC, 50/60Hz	[kA]	36	50	65	36 50 65	36	50	65	100	150	36 50 65 100 150
500V AC, 50/60Hz	[kA]	30	36	50	36 50 65	30	36	50	60	70	30 36 50 60 70
525V AC, 50/60Hz	[kA]	22	35	35	22 35 35	20	25	30	36	50	20 25 30 36 50
690V AC, 50/60Hz	[kA]	6	8	10	6 8 10	10	12	15	18	20	10 12 15 18 20
250V DC, 2 Poles in Series	[kA]	36	50	70	36 50 70	36	50	70	85	100	36 50 70 85 100
500V DC, 2 Poles in Series	[kA]	—	—	—	—	—	—	—	—	—	—
500V DC, 3 Poles in Series	[kA]	36	50	70	36 50 70	36	50	70	85	100	36 50 70 85 100
750V DC, 3 Poles in Series	[kA]	—	—	—	—	—	—	—	—	—	—
Rated service short-circuit breaking capacity, I _{cs}											
220/230/240V AC, 50/60Hz	[kA]	75% (50)	75%	75%	75% 75% 75%	100%	100%	100%	100%	100%	100% 100% 100% 100% 100%
380V AC, 50/60Hz	[kA]	100%	100%	75%	100% 100% 75%	100%	100% 100%	100%	100%	100%	100% 100% 100% 100% 100%
415V AC, 50/60Hz	[kA]	100%	75%	50%	100% 75% 50%	100%	100%	100%	100%	100%	100% 100% 100% 100% 100%
440V AC, 50/60Hz	[kA]	50%	50%	50%	50% 50% 50%	100%	100%	100%	100%	100%	100% 100% 100% 100% 100%
500V AC, 50/60Hz	[kA]	50%	50%	50%	50% 50% 50%	100%	100%	100%	100%	100%	100% 100% 100% 100% 100%
525V AC, 50/60Hz	[kA]	50%	50%	50%	50% 50% 50%	100%	100%	100%	100%	100%	100% 100% 100% 100% 100%
690V AC, 50/60Hz	[kA]	75%	50%	50%	75 50 50%	100%	100%	100%	75%	75%	100% 100% 100% 75% 75%
250V DC, 2 Poles in Series	[kA]	100%	100%	75%	100% 100% 75%	100%	100%	100%	100%	100%	100% 100% 100% 100% 100%
500V DC, 2 Poles in Series	[kA]	—	—	—	—	—	—	—	—	—	—
500V DC, 3 Poles in Series	[kA]	100%	100%	75%	100% 100% 75%	100%	100%	100%	100%	100%	100% 100% 100% 100% 100%
750V DC, 3 Poles in Series	[kA]	—	—	—	—	—	—	—	—	—	—
Mechanical Life	[No. Ops]	25 000				25 000					
	[Ops/hr]	240				240					
Electrical Life @ 415V AC	[No. Ops]	8000				8000					
	[Ops/hr]	120				120					
Ambient Temp. w/out derating	°F [°C]	104 °F [40 °C]				104 °F [40 °C]					
Storage Temperature	°F [°C]	-40...+176 °F [-40...+80 °C]				-40...+176 °F [-40...+80 °C]					
Dimensions [Width/Depth/Height]	[mm]	3 poles: 76.2x70x130				3 poles: 90x82.5x130					
	[mm]	4 poles: 101.6x70x130				4 poles: 120x82.5x130					

★ IEC version with a 160 A I_{cu} rating
† Cannot be reverse fed above 480V

Molded Case Circuit Breakers

Approximate Dimensions — 125 A, H-Frame

Dimensions are in millimeters. Dimensions are not intended to be used for manufacturing purposes.

Panel Mounted Molded Case Circuit Breaker

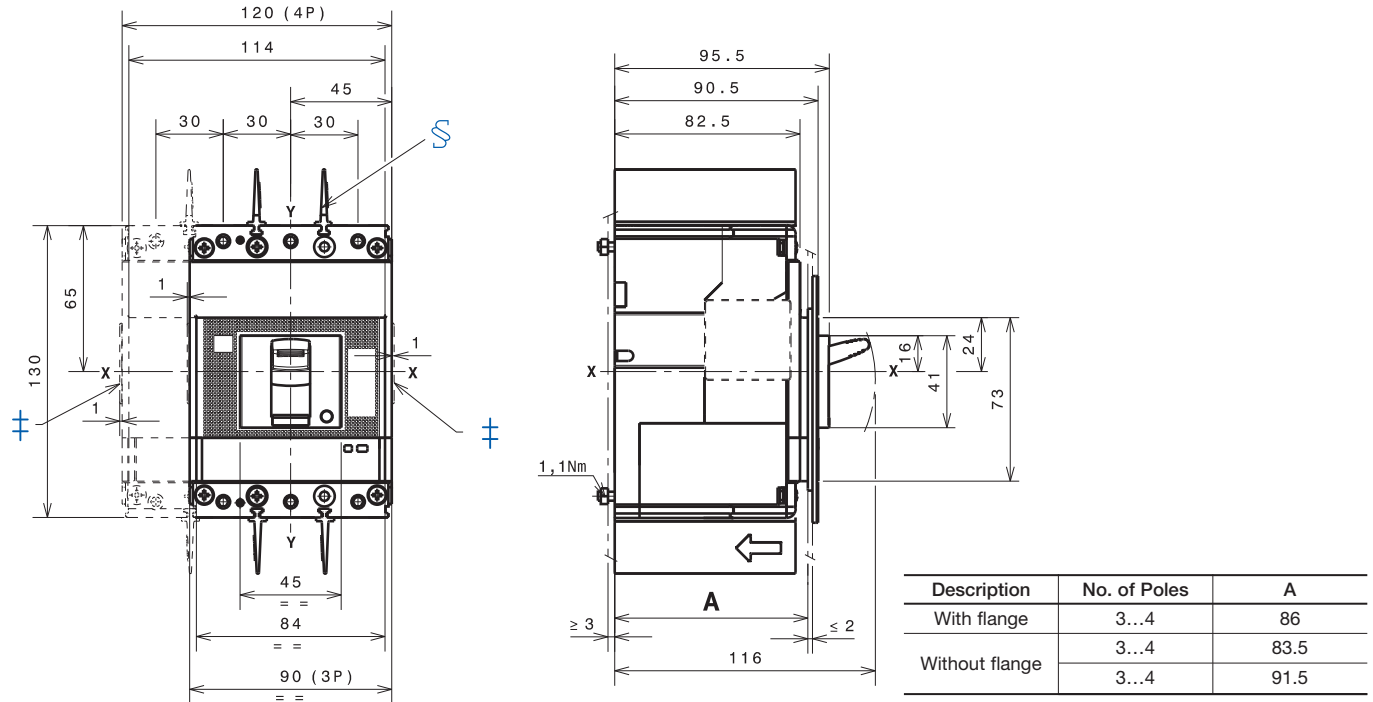

‡ Overall dimensions of optional wiring ducts
 § Required 25 mm insulating phase barriers provided

DIN Rail Mounted Molded Case Circuit Breaker

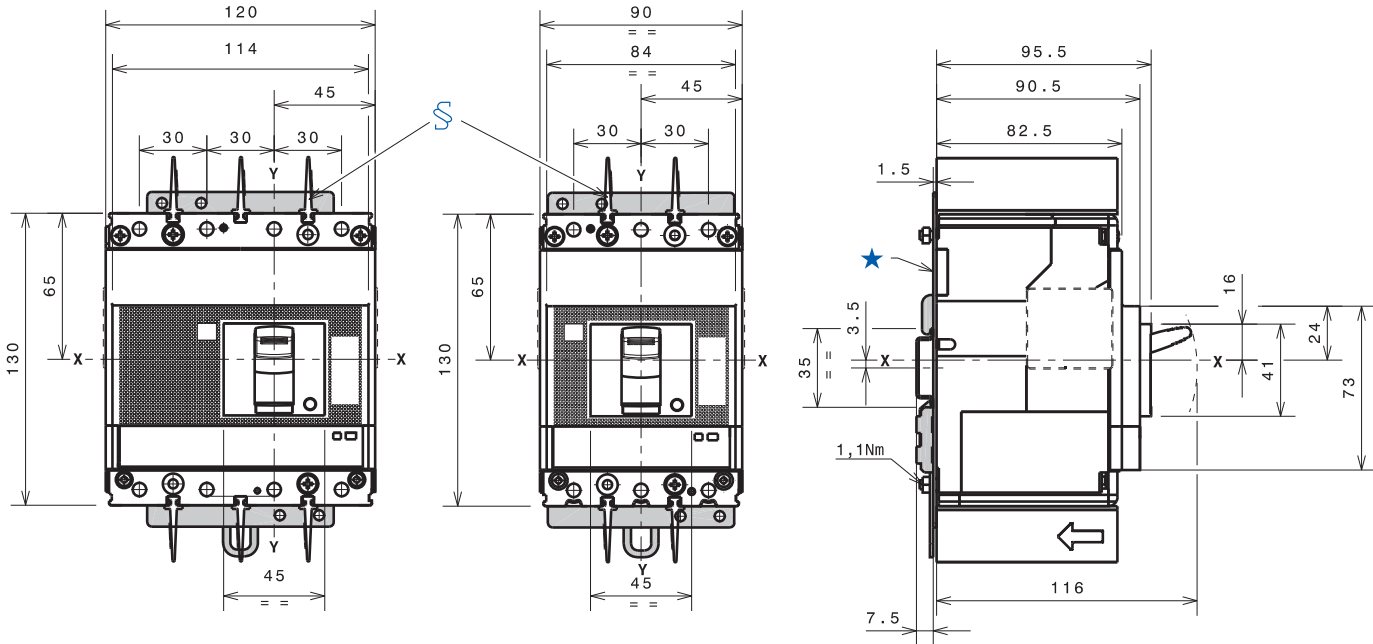

★ Mounting bracket
 § Required 25 mm insulating phase barriers provided

Molded Case Circuit Breakers

Approximate Dimensions — 125 A, H-Frame

Drilling Template for Molded Case Circuit Breaker Mounting

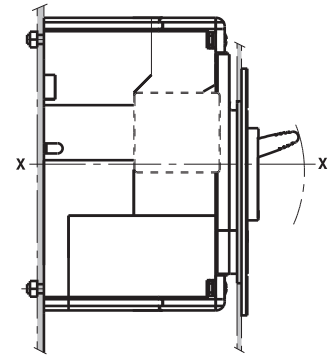
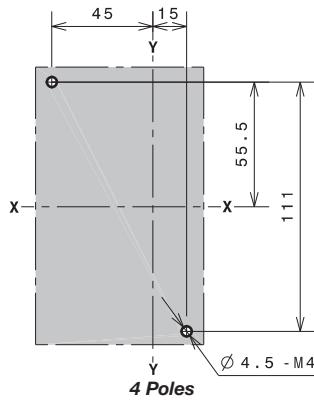
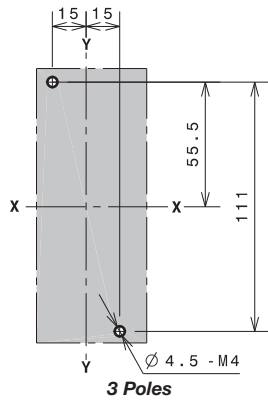

Cat. Nos. 140G-H-ECM, -ECM4 Terminals

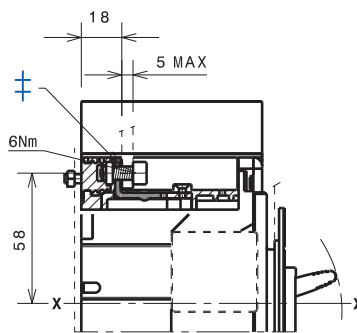
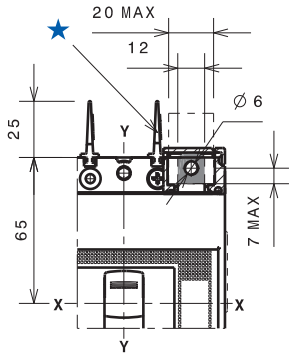

- ★ Required 25 mm insulating phase barriers provided
- ‡ Front terminals for busbar connection

Bulletin 140G
Molded Case Circuit Breakers
 Approximate Dimensions — 125 A, H-Frame

Cat. Nos. 140G-H-EXT3, -EXT4 Extended Terminals

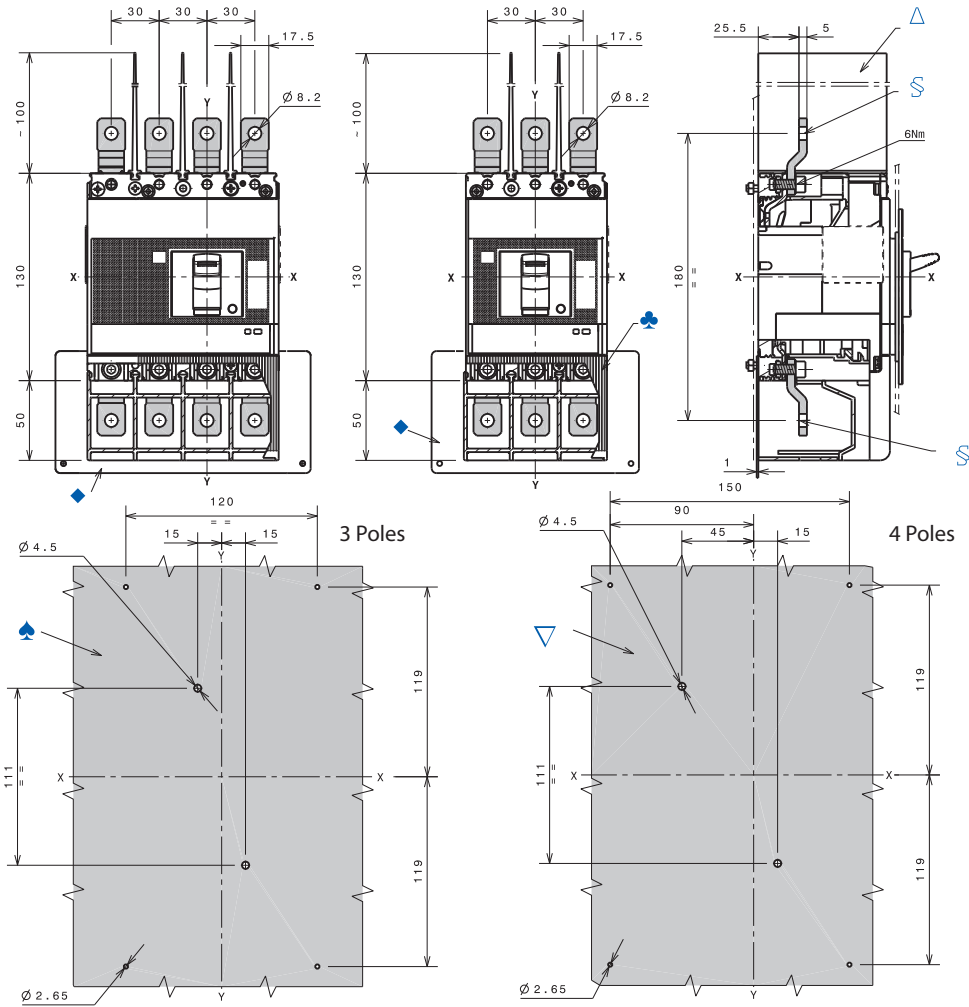

- § Extended terminals
- ♣ Optional terminal covers with IP40 protection provided
- △ Required 100 mm insulating phase barriers provided
- ♦ Required internal insulating plate provided for breakers with $U_g > 440V$
- ♣ Drilling template for 3-pole molded case circuit breaker, $U_g > 440V$ (required)
- ▼ Drilling template for 4-pole molded case circuit breaker, $U_g > 440V$ (required)

Cat. Nos. 140G-H-EXS3, -EXS4 Spreader Terminals

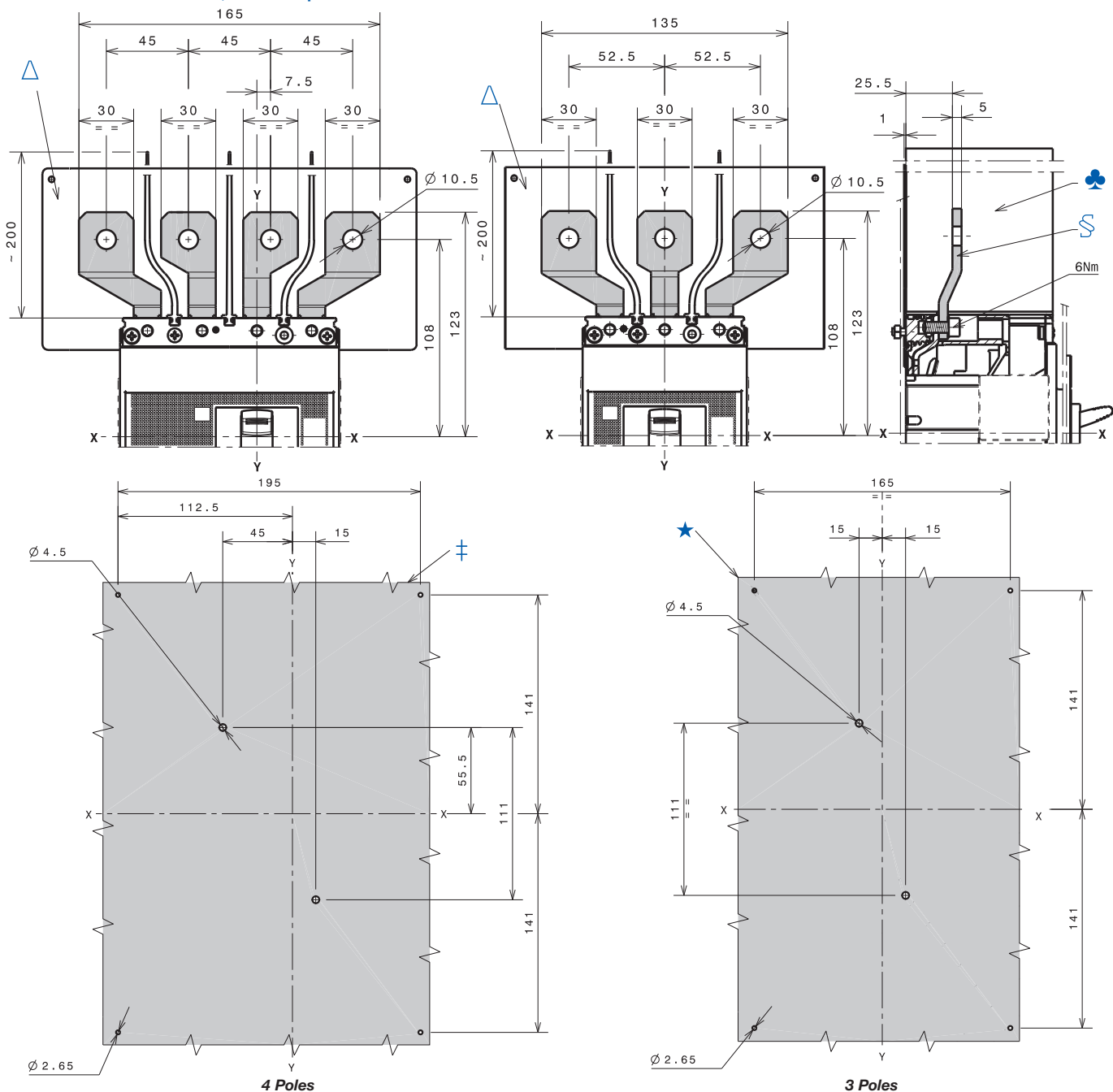

- ★ Drilling template for 3-pole molded case circuit breaker, $U_e > 440V$ (required)
- ‡ Drilling template for 4-pole molded case circuit breaker, $U_e > 440V$ (required)
- § Extended spread terminals
- ♣ Required 200 mm insulating phase barriers provided
- △ Required insulated plate provided for breakers, with $U_e > 440V$

Bulletin 140G
Molded Case Circuit Breakers
 Approximate Dimensions — 125 A, H-Frame

Cat. Nos. 140G-H-TLC13, -TLC14 Terminals

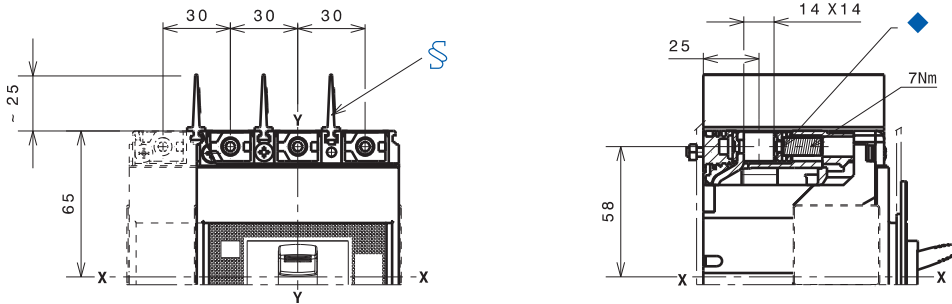

- § Required 25 mm insulating phase barriers provided
- ◆ Copper terminals.

Cat. Nos. 140G-H-MTL63, -MTL64 Terminals

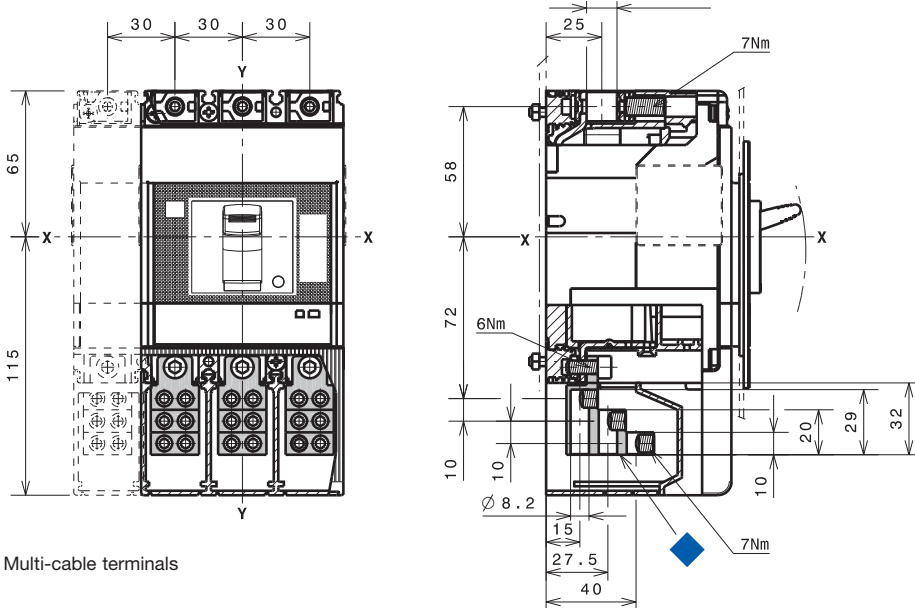

- ◆ Multi-cable terminals

Cat. No. 140G-H-RMB, -RMY Direct Rotary Operating Handle

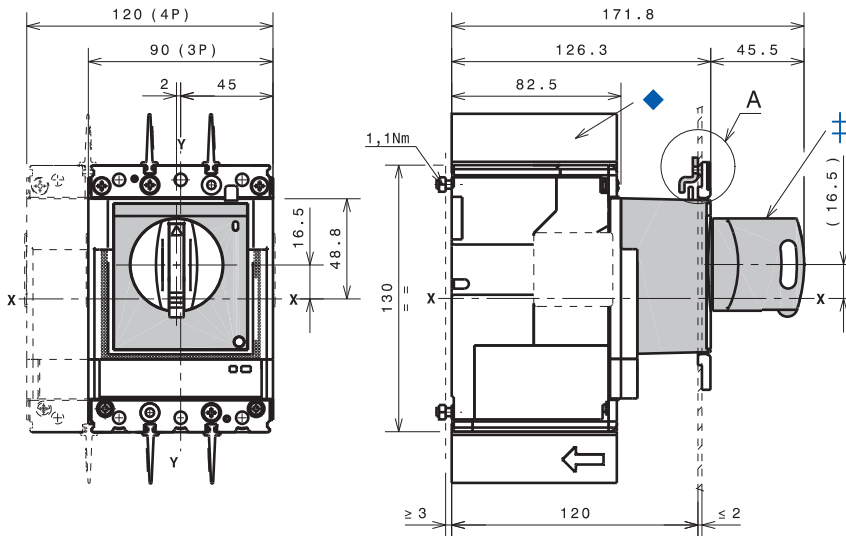

- ‡ Rotary handle operating mechanism on molded case circuit breaker
- ◆ Required 25 mm insulating phase barriers provided

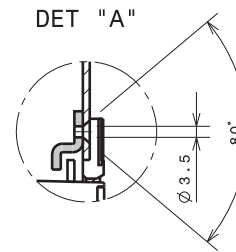

Cat. No. 140G-H-RVM... Rotary Handle Operating Mechanism — Door Mounted

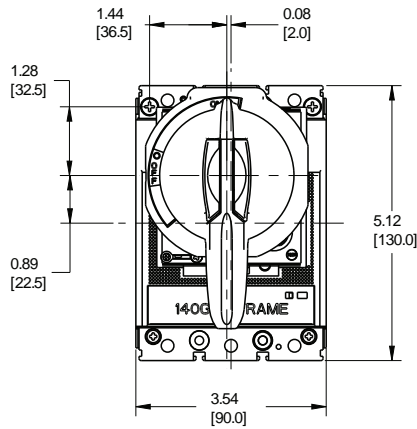
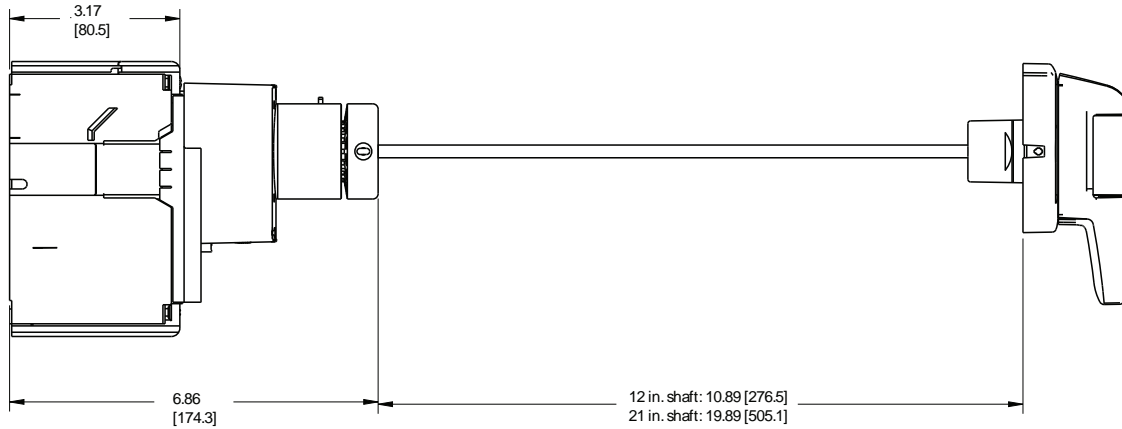

3-Pole

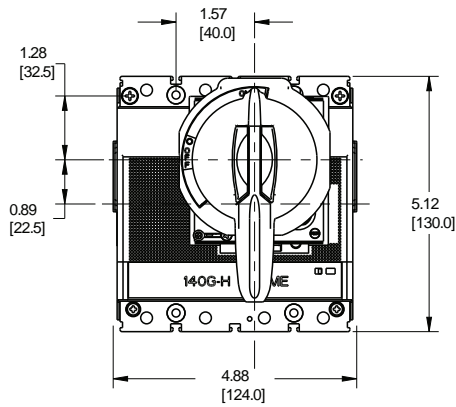

4-Pole

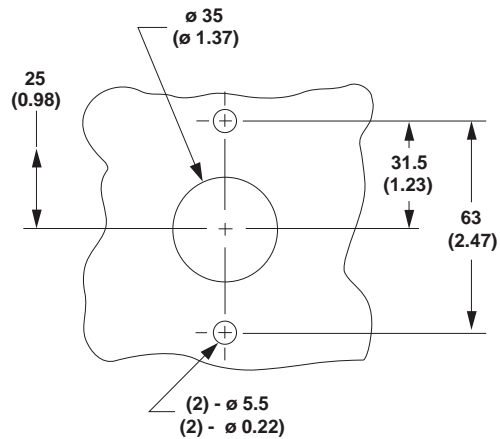
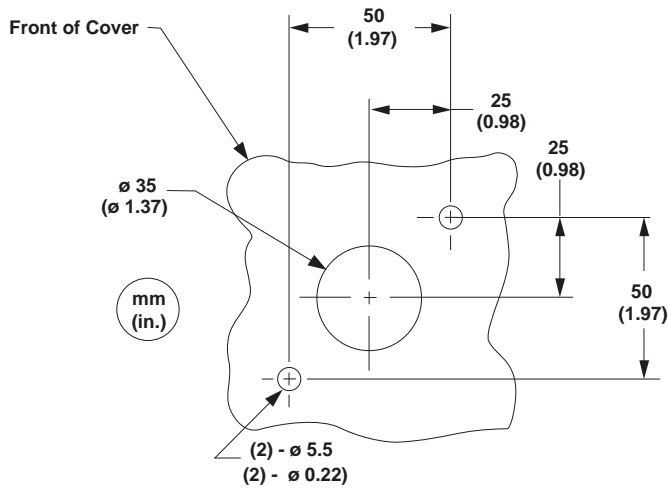

Bulletin 140G
Molded Case Circuit Breakers
 Approximate Dimensions — 125 A, H-Frame

Cat. No. 140G-H-EOP... Motor Operator

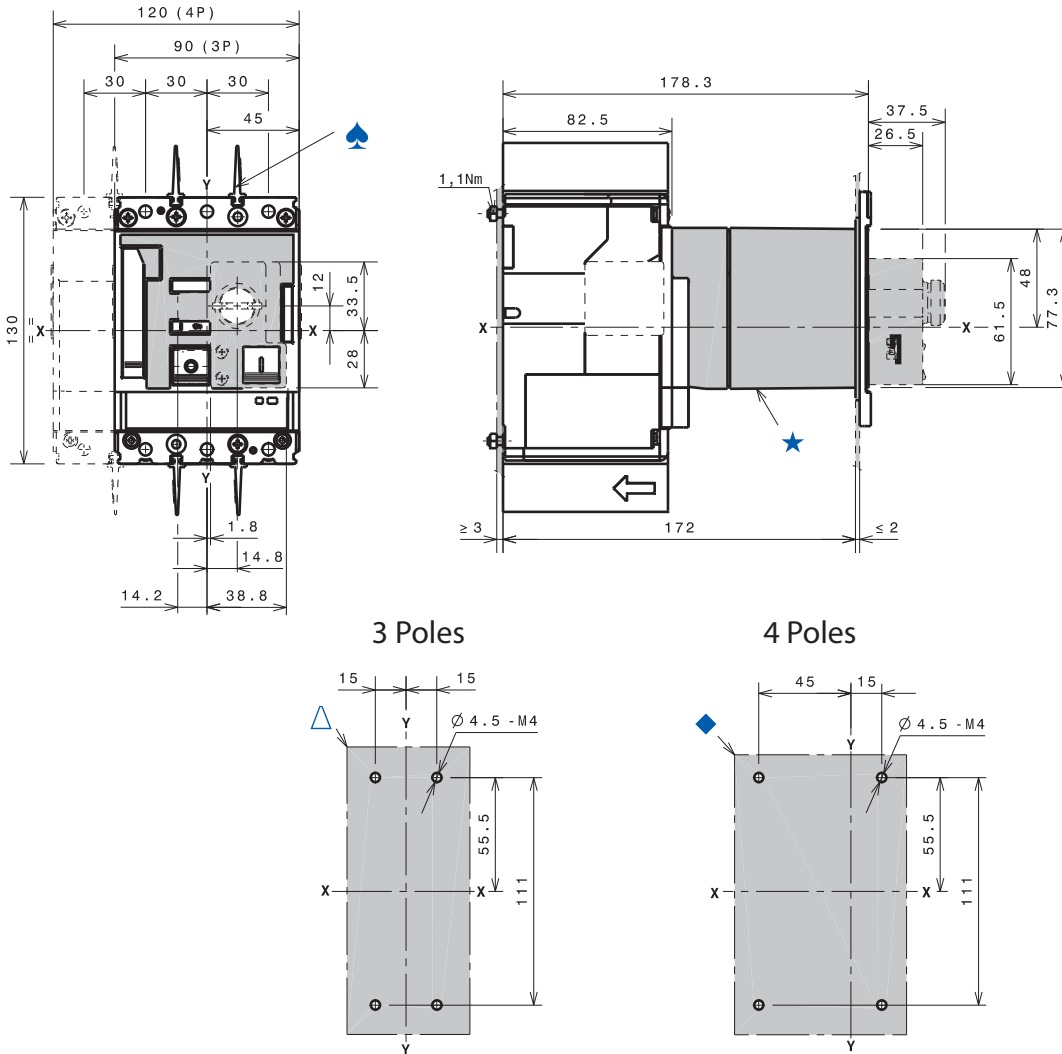

- ★ Motor operator
- △ Drilling template for 3-pole molded case circuit breaker, mounted on mounting plate
- ◆ Drilling template for 4-pole molded case circuit breaker, mounted on mounting plate
- ♣ Required 25 mm insulating phase barriers provided

Cat. No. 140G-H-ELP1604 Residual Current Release Module

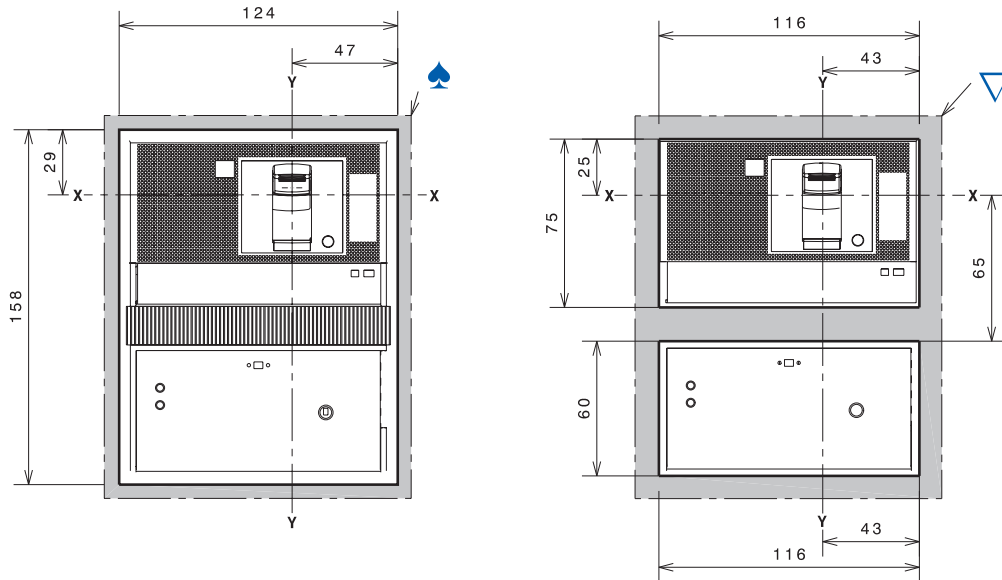
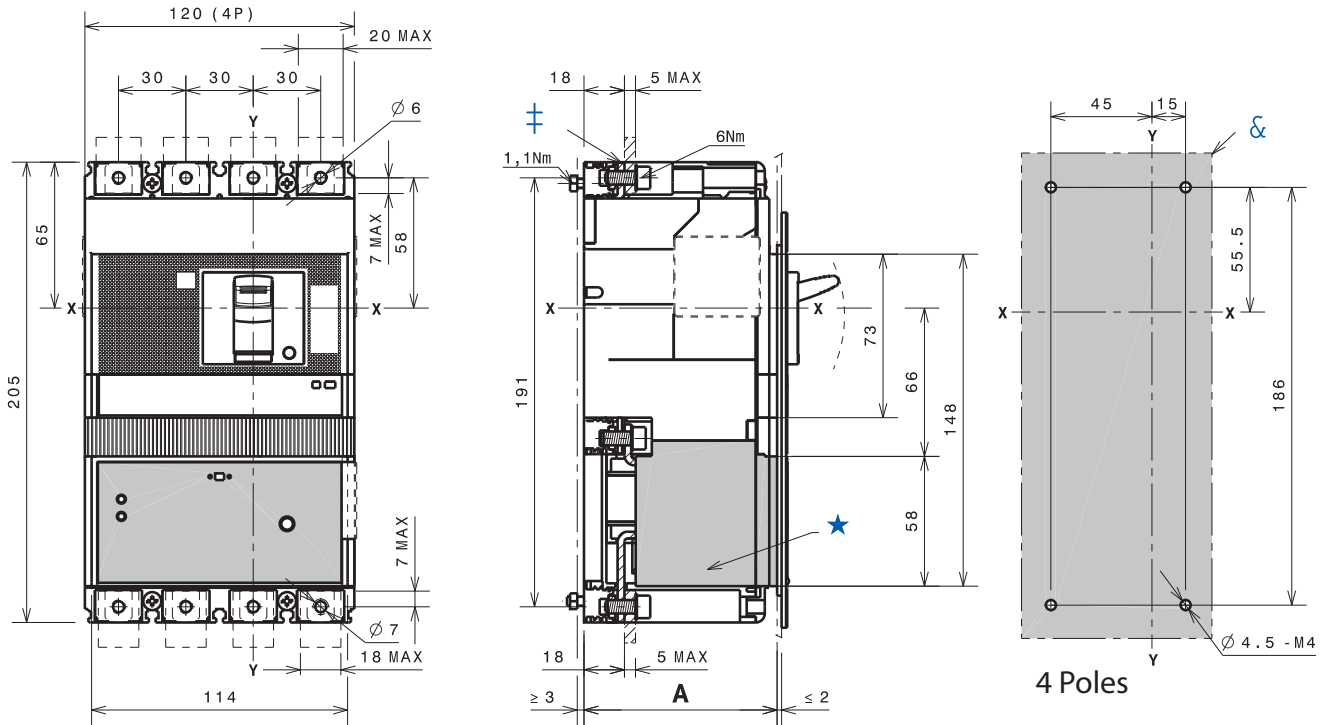

Description	No. of Poles	A
With flange	4	86
Without flange	4	83.5

- ★ Residual current module
- ‡ Front terminals
- ◆ Drilling template — door with direct rotary mechanism and flange
- ▽ Drilling template — door with direct rotary mechanism, without flange
- & Drilling template — molded case circuit breaker mounting on mounting plate